

Yamato

Ovens Available From:



For Information and to Order
Contact Us At:

323-770-0634 800-574-2748
Email: sales@LRE.com Web Site:
www.LRE.com

Variable wind-speed constant-temperature
drying oven
(2in1 oven)

DNF301
DNF401/411
DNF601/611

Instruction Manual

First Edition

● Thank you for purchasing “Variable wind-speed constant-temperature drying oven (2in1 oven) DNF301/ DNF401/411/ DNF601/611” of Yamato Scientific Co., Ltd.

● In order to use this Equipment properly, please read this Instruction Manual and Warranty Card thoroughly before use. Keep them in safe place close to this Equipment so that you can refer to them any time.

⚠ Warning: Please read the important warning notes in this Manual carefully and thoroughly, and get the good understanding of their contents before using this Equipment.

Yamato Scientific America Inc.
Santa Clara, CA

Printed on recycled paper

1. Safety Precautions	1
Explanation of symbols	1
List of symbols	2
Residual risk map	3
Warnings·Cautions.....	4
List of residual risks	5
2. Before operating the Equipment	6
Precautions when installing the Equipment	6
3. Names and functions of each part	11
External view	11
3. Names and functions of each part	12
System	12
Structure diagram	13
Control Panel	14
4. Operating procedure	15
Prior confirmation	15
Date & Time setting	16
Buzzer function selection	18
Fixed temperature operation	20
Auto stop operation	24
4. Operating procedure	27
Operation of the variable wind-speed function and the method of entry	30
Program operation	32
Programming Method	35
Programming Method	36
How to copy or delete programs	43
About the wait function	45
Setting key lock mode	46
Calibration offset	47
Calibration offset	48
Setting the recovery mode	49
Resetting integrated CO2 volume and CO2 emission factor	50
Backup data saving / reading out / resetting	52
Monitoring data	53
Independent Overheat Prevention Device	55
5. Handling precautions	56
Warnings and Cautions	56
Warnings and Cautions	57
6. Maintenance method	62
Daily inspection/maintenance	62
7. Long storage and scrap	63
When not using the Equipment for a long time / when scrapping	63

Matters to consider when scrapping the Equipment	63
8. When a trouble occurs	64
Message error table	64
Troubleshooting	66
9. After sales service and warranty	67
Request to repair parts	67
10. Specifications	68
Specifications	68
11. Accessory	71
List of accessories	71
12. Wiring diagram	73
DNF301 Wiring diagram	73
DNF401 Wiring diagram	74
DNF411 Wiring diagram	75
DNF601 Wiring diagram	76
DNF611 Wiring diagram	77
Wiring diagram part symbols	78
13. List of dangerous substances	79
14. Standard setup manual	80
15. Reference data	81
DNF301	81
DNF301	82
DNF401	83
DNF401	84
DNF601	85
DNF601	86

1. Safety Precautions

Explanation of symbols

About symbols

Various symbols are provided in this Instruction Manual and on the product to ensure safe operation. Improper handling of this Equipment without understanding their contents will lead to the results classified below. Be sure to fully understand the description of symbols below before proceeding to the text of this Manual.

 **Warning** Indicates a situation which may result in death or serious injury (Note 1.)

 **Caution** Indicates a situation which may result in minor injury (Note 2) and property damages (Note 3.)

(Note 1) Serious injury means a wound, an electrical shock, a bone fracture or intoxication that may leave after effects or require hospitalization or outpatient visits for a long time

(Note 2) Minor injury means a wound or an electrical shock that does not require hospitalization or outpatient visits for a long time.

(Note 3) Property damage means damage to facilities, devices and buildings or other properties.

Meanings of symbols



This symbol indicates a matter urging user to follow the warning ("caution" included).
Specific description of warning is indicated near this symbol.



This symbol indicates prohibitions.
Specific prohibition is indicated near this symbol.



This symbol indicates matters that the user must perform.
Specific instruction is indicated near this symbol.

1. Safety Precautions

List of symbols

Warning



General Warnings

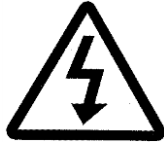

Danger!: High Voltage



Danger!: High Temperature



Danger!: Moving Part



Danger!: Explosion Hazard

Caution



General Cautions



Caution: Electrical Shock!



Caution: Burns!



Caution: Heating Container without water!



Caution: Water Leak!



Caution: For water only



Caution: Toxic Chemicals

Prohibitions



General Prohibited Actions



No open flame



Do not disassemble



Do not touch

Compulsions



General Mandatory Actions



Connect grounding wire



Leveled Installation

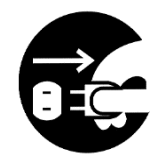

Disconnect Power



Regular Inspection

1. Safety Precautions

Residual risk map

The figure shows the position to apply the caution seal.

The numbers shown in the figure represent the numbers of residual risk relevant to the location concerned, which are provided in the List of Residual Risks for this product. For details of individual residual risks, see the List of Residual Risks.

【DNF301/401/411/601/611】

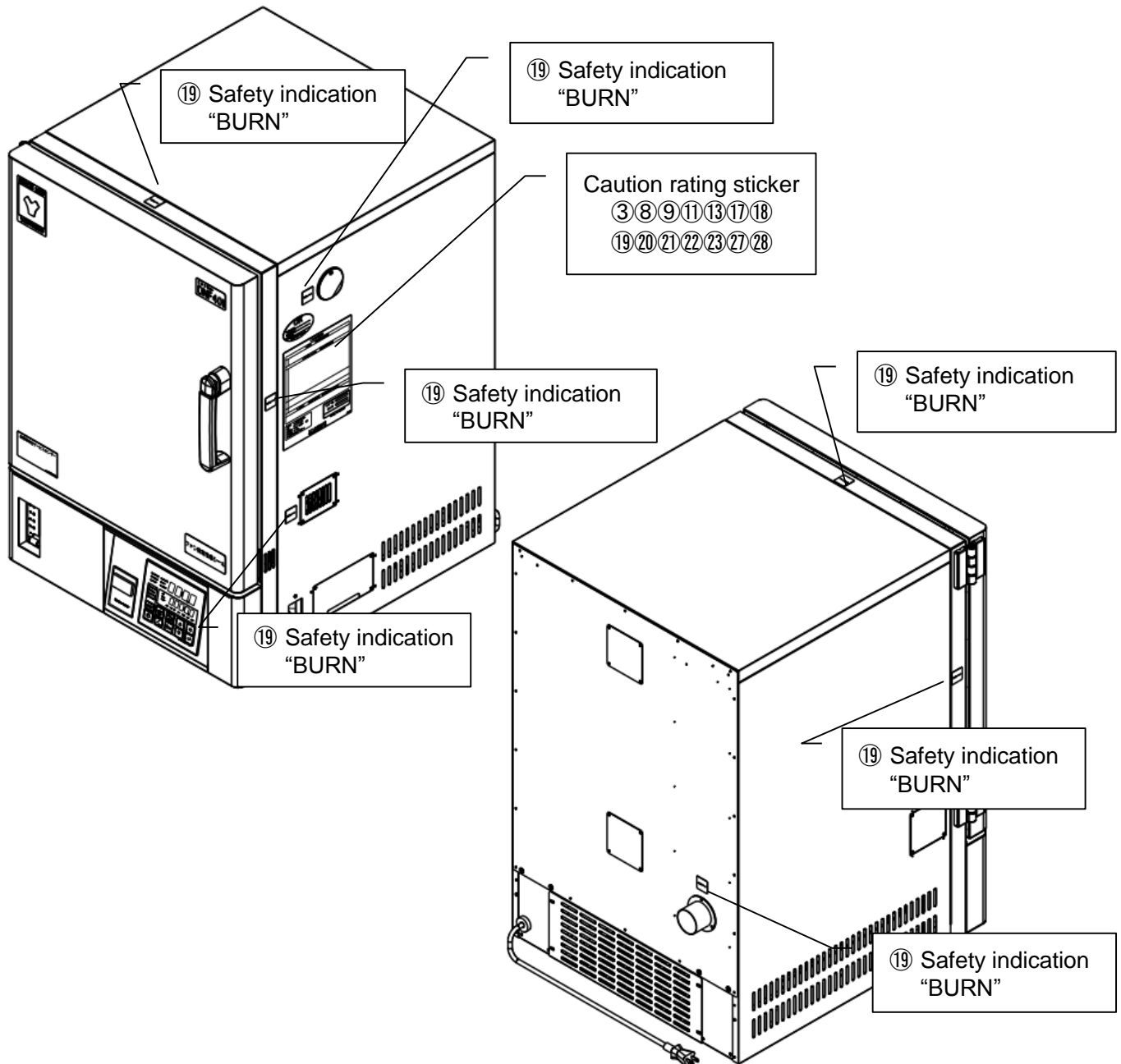

※Contact us when the caution texts are illegible because the nameplate has peeled off or characters are eliminated. We will send you a new name plate (for value)

1. Safety Precautions

Warnings·Cautions

List of residual risks (Instructions for avoiding risks)

This list summarizes residual risks to avoid personal injuries or damages to properties during or related to the use of the product.

Be sure to fully understand or receive instructions on how to use, maintain and inspection of the product before starting operation.

During or on carrying-in or installation				
No	Degree of risks	Details of risks	Protective measures to be implemented by the machine users	Relevant sections
①	Caution	Injury	Use cargo handling equipment for carrying and installation. Two or more people shall be necessary when transporting by humans.	2.3
②	Warning	Fire or electrical shock	Carefully select an installation site and take care for the installation environment.	2.1
③	Caution	Injury	Install on a level surface.	2.3
④	Caution	Injury	Implement safety measures for installation.	2.4
⑤	Caution	Injury	Implement appropriate safety measures after installation.	2.5
⑥	Warning	Fire	Assure sufficient ventilation for the unit.	2.6
⑦	Warning	Fire or electrical shock	Do not use the unit at a place that may be subject to splashes of liquid.	2.7
⑧	Warning	Explosion or fire	Do not use the unit in a flammable or an explosive atmosphere.	2.8
⑨	Warning	Fire or electrical shock	Connect the power supply to the dedicated distribution board.	2.9
⑩	Warning	Fire or electrical shock	Take care for handling of the power cord.	2.12
⑪	Warning	Fire or electrical shock	Be sure to connect the ground wire.	2.10 2.11
⑫	Warning	Fire or electrical shock	Do not disassemble nor modify the Equipment.	2.13

During operation				
No	Degree of risks	Details of risks	Protective measures to be implemented by the machine users	Relevant sections
⑬	Warning	Explosion and fire	Do not use an explosive or combustible substance.	5.1
⑭	Warning	Explosion and fire	When using resin containers, take care not to allow the temperature to rise beyond their service temperature limit.	5.2
⑮	Warning	Fire or electrical shock	Immediately turn the ELB off when an abnormality should occur.	5.3
⑯	Warning	Fire, electrical shock or burning	Do not put any foreign objects in the unit.	5.4
⑰	Warning	Burning	Take extreme care for handling of specimens after operation at a high temperature.	5.5
⑱	Warning	Burning	Take extreme care when opening the door during operation at a high temperature.	5.6 5.26
⑲	Warning	Burning	Do not touch any hot surfaces.	5.7
⑳	Warning	Fire	Always set the sample, etc. on the dedicated shelf plate.	2.14

1. Safety Precaution

List of residual risks

During operation				
No	Degree of risks	Details of risks	Protective measures to be implemented by the machine users	Relevant sections
⑳	Caution	Injury	Do not attempt to climb on the unit.	5.8
㉑	Caution	Injury	Do not put any objects on the unit.	5.9
㉒	Warning	Fire	Turn the ELB off when thunder is heard.	5.10
㉓	Caution	Burning and injury	Use the unit at the appropriate temperature (within the temperature control range).	5.13
㉔	Warning	Burning	Pay attention to the bath internal temperature at end of operation.	5.27
㉕	Warning	Fire and electrical shock	Take care when handling samples.	5.17
㉖	Warning	Fire	Make a temperature setting for the standalone overheat preventive unit.	5.20

During inspection and maintenance				
No	Degree of risks	Details of risks	Protective measures to be implemented by the machine users	Relevant sections
㉗	Warning	Fire or electrical shock	Inspect the ELB and the standalone overheat preventive unit at regular intervals.	5.22
㉘	Warning	Fire or electrical shock	Remove the power cord before inspection or maintenance.	6
㉙	Warning	Burning	Start maintenance only after the device has returned to the normal temperature.	6
㉚	Warning	Fire or electrical shock	Do not attempt to disassembly the devices.	6

When you are not going to use the unit for a long time or when discarding the unit				
No	Degree of risks	Details of risks	Protective measures to be implemented by the machine users	Relevant sections
㉛	Warning	Fire or electrical shock	Turn power off and remove the power cord.	7
㉜	Caution	Injury, trapping	Do not leave the unit at a place where children may play.	7
㉝	Caution	Injury	When the equipment is to be disposed of, remove the hinge and door lock to prevent tight closing of the door.	7

2. Before operating the Equipment

Precautions when installing the Equipment

1. Choose proper place for installation



Do not install this Equipment in the place where:

- the location is rough, dirty or un-leveled.
- flammable gas, explosive gas or corrosive gas will be generated.
- ambient temperature will be more than 35°C or less than 5°C.
- ambient temperature will fluctuate.
- there is excessive humidity and dusty.
- there is constant vibration.
- power supply is instable.
- Liquid may splash
- there is direct sunlight.
- outside the building.



Install the Equipment(s) at the place with sufficient space as specified as below
An exhaust port exists in the back of main body. When the exhaust duct is not provided, install the product while paying attention to the back space and checking for any combustibles.

【DNF301/401/411/601/611】

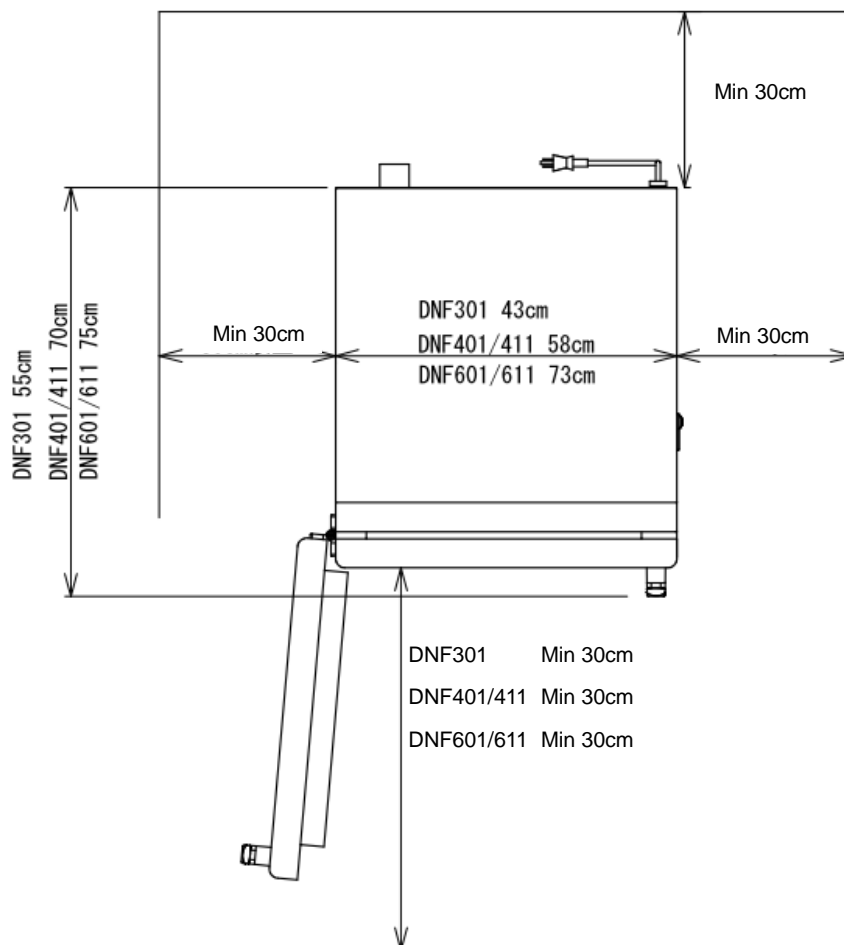

2. Before operating the Equipment

Precautions when installing the Equipment

2. For Ventilation



When the product is used (with the damper opened) for ventilation, take such measures as to ensure sufficient ventilation around the installation location. When ventilation around the product is not sufficient, hot air discharged through the exhaust port may cause increase in temperature of the location or fume and gas generated from the sample may fill the space. Be sure to connect the exhaust duct to the exhaust port to ensure discharge of hot air to the outside. The exhaust duct is optionally available and should be ordered separately. See "P. 70 List of Accessories."

3. Install the Equipment on leveled location.



Install this Equipment on leveled floor. If it is installed on rough and/or slope floor, vibration or noise will be occurred, and unexpected trouble and malfunction may be happened.



Weight of this Equipment is as follows:

DNF301 approx. 50kg/DNF401/411 approx. 75 kg /DNF601/611 approx. 90kg

Use cargo handling equipment for carrying and installation. Two or more people shall be necessary when transporting by humans.

4. Implement safety measures when installing the unit.



May be injured by moved and/or fallen this Equipment down by earthquake and/or unexpected impact. Recommend to install this Equipment at the place away from the access door and to take other safety steps.

5. Implement appropriate safety measures after installation.



May be injured by moved and/or fallen this Equipment down by earthquake and/or unexpected impact.

To ensure the safety, be sure to provide any adequate measur to the main body and to the installation surface to prevent overturn.

6. Ventilate sufficiently for the Equipment



Do not operate the Equipment blocked in the radiating slit holes-Louver on its side and back panels and top panel. Refer to 3. "Name and Functions of each part" on page 11 for the location of Louvers.

Internal temperature will rise, causing a malfunction of the controller to compromise the performance as well as to cause a possible accident or a fire.

7. Do not operate at the location of liquid splashing.



Do not operate this Equipment at the location of liquid splashing. If Controller of this Equipment will be wetted by splashing any kind of liquid, it may cause accident, controller malfunction, electrical shock and/or fire.

8. Never operate in an atmosphere where flammable or explosive gas is present.



Never operate this Equipment in an atmosphere where flammable or explosive gas is present. This Equipment is not explosion-proof. Spark may be discharged by switching Earth Leakage Breaker (ELB) "ON(|)" and "OFF(○)" and also relay during operation, and then it may cause fire or explosion.



See Chapter 13. "List of Dangerous Substances" for flammable and explosive gases on page .76

2. Before operating the Equipment

Precautions when installing the Equipment

9. Connect Power Cord/Power Cable to receptacle or switch board of facilities.



Connect Power Cord/Power Cable to suitable receptacle/switch board of facilities according to electrical requirements as follows.

Electrical requirements:	DNF301	AC115V single phase 50/60Hz	8A or more (ELB capacity ; 15A)
	DNF401	AC100V single phase 50/60Hz	11.5A or more (ELB capacity ; 15A)
	DNF411	AC200V single phase 50/60Hz	7.5A or more (ELB capacity ; 10A)
	DNF601	AC100V single phase 50/60Hz	15.5A or more (ELB capacity ; 20A)
	DNF611	AC200V single phase 50/60Hz	10A or more (ELB capacity ; 15A)

The operational voltage range is $\pm 10\%$, the voltage range where the specified performance is guaranteed is rating $\pm 5\%$, the frequency is rating $\pm 1\%$.

※ Check line voltage of its receptacle/switch board of facilities and/or whether utilize the same line with other equipments or not, if this Equipment does not start up/operate even to turn Earth Leakage Breaker(ELB) On(|). Take correct action for the solution, such as changing its power source away from other equipment.

Multiple plugs with a branch outlet or extension with the cord reel may cause voltage drop, resulting in deterioration of the heating capacity or of the temperature control performance.

10. Must connect grounding wire properly. (DNF301 DNF401 specifications)



- Must connect grounding wire properly to grounding line or terminal in order to avoid electrical shock due to electrical leakage.
- Never connect grounding wire to gas line pipe or water line pipe due to fire or electrical shock.
- Never connect grounding wire to telephone grounding line or to lightning conductor due to fire or electrical shock.
- Never connect multiple plug to single receptacle due to generating heat dangerously.

Connect to grounded receptacle.

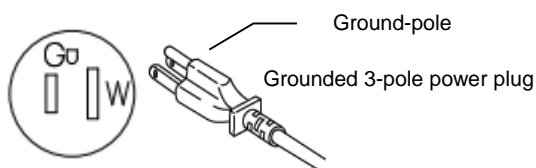

Receptacle with ground connection

Use grounded adaptor for ungrounded receptacle

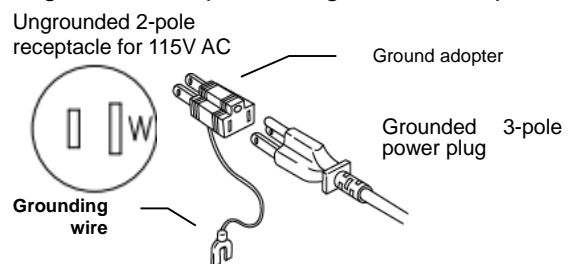

Ground adaptor

When there is no ground terminal.

- Require to ground by Electrical Equipment Technical Standards Section 19-class D in Japan. Please contact with local dealer, local electrician, or Yamato Customer Service Center.
- Insert grounded power plug into ground adaptor. Connect grounding wire(green) of ground adaptor to ground terminal on switch board of facilities.

2. Before operating the Equipment

Precautions when installing the Equipment

11. Must connect grounding wire properly. (DNF411 DNF601 DNF611 specifications)



Require to ground by Electrical Equipment Technical Standards Section 19-class D (Grounding Resistance Max. 100Ω) in Japan, if grounding terminal is not provided. Please contact with local dealer, local electrician, or Yamato Customer Service Center.



Connect the terminals firmly to switch board of facilities or appropriate power plug. Power plug itself will not be included as an accessory of this Equipment. Connect to the power supply facilities that meet the electric capacity. (※AC115V for DNF601)

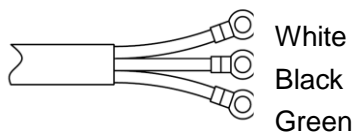

Core color	Wiring on the distribution board
White	Ground side
Black	Voltage side
Green	Earth



Never connect grounding wire to gas line pipe, water line pipe or telephone grounding wire due to fire or electric shock.

12. Take care for handling of the power cord.



Never operate this Equipment at bundled Power Cord/Power Cable. May heat its Cord/Cable and then cause fire, if operate at bundled it.

Do not modify, bend forcibly, twist or pull Power Cord/Power Cable. Otherwise, may cause fire and/or electrical shock.

Do not damage Power Cord/Power Cable by setting under any desk and/or chairs, or by pinching it between objects. Otherwise, may cause fire and/or electrical shock.

Do not place Power Cord/Power Cable close to kerosene heater, electric heater, or other heat-generating devices.



Turn immediately off (○) Earth Leakage Breaker (ELB) and also disconnect Power Plug/breaker of switch board of facilities, if it is damaged such as exposure of core wire or disconnection. Turn immediately off (○) Earth Leakage Breaker (ELB) and also disconnect Power Plug/breaker of switch board of facilities, if it is damaged such as exposure of core wire or disconnection. Connect Power Cord/Power Cable to appropriate receptacle or switch board of facilities.

13. Never disassembly nor modify the Equipment.



Never disassemble nor modify this Equipment. Those actions may cause this Equipment malfunction, fire or electric shock.

14. Installation of shelf boards and samples (Do not put samples directly on the bottom of the chamber.)



The models DNF301/401/411 and DNF601/611 have two shelf boards

One of those boards is screwed to the lowest shelf rung on the shelf pillar inside at the time of factory shipping.

Put other shelf boards to places you want in the bath.

Placing the sample directly on the bottom of product may disturb the air circulation and make the normal temperature control difficult, resulting in burn of the sample by abnormal temperature and fire. Always place the sample on the shelf plate and never place it directly on the bottom.

Do not use the shelf plates other than dedicated ones. Otherwise normal temperature control cannot be achieved.

2. Before operating the Equipment

Precautions when installing the Equipment

15. Always use the stacking attachment when stacking one main body on the other. (DNF301/401/411/601/611)



When stacking one main body on the other for use, be sure to use the attachment (optional) and never stack more than two units.

Be sure to take any overturn preventive measures for the main body (the lower one) and the installation surface.

Refer to P.70, List of List of accessories.

3. Names and functions of each part

External view

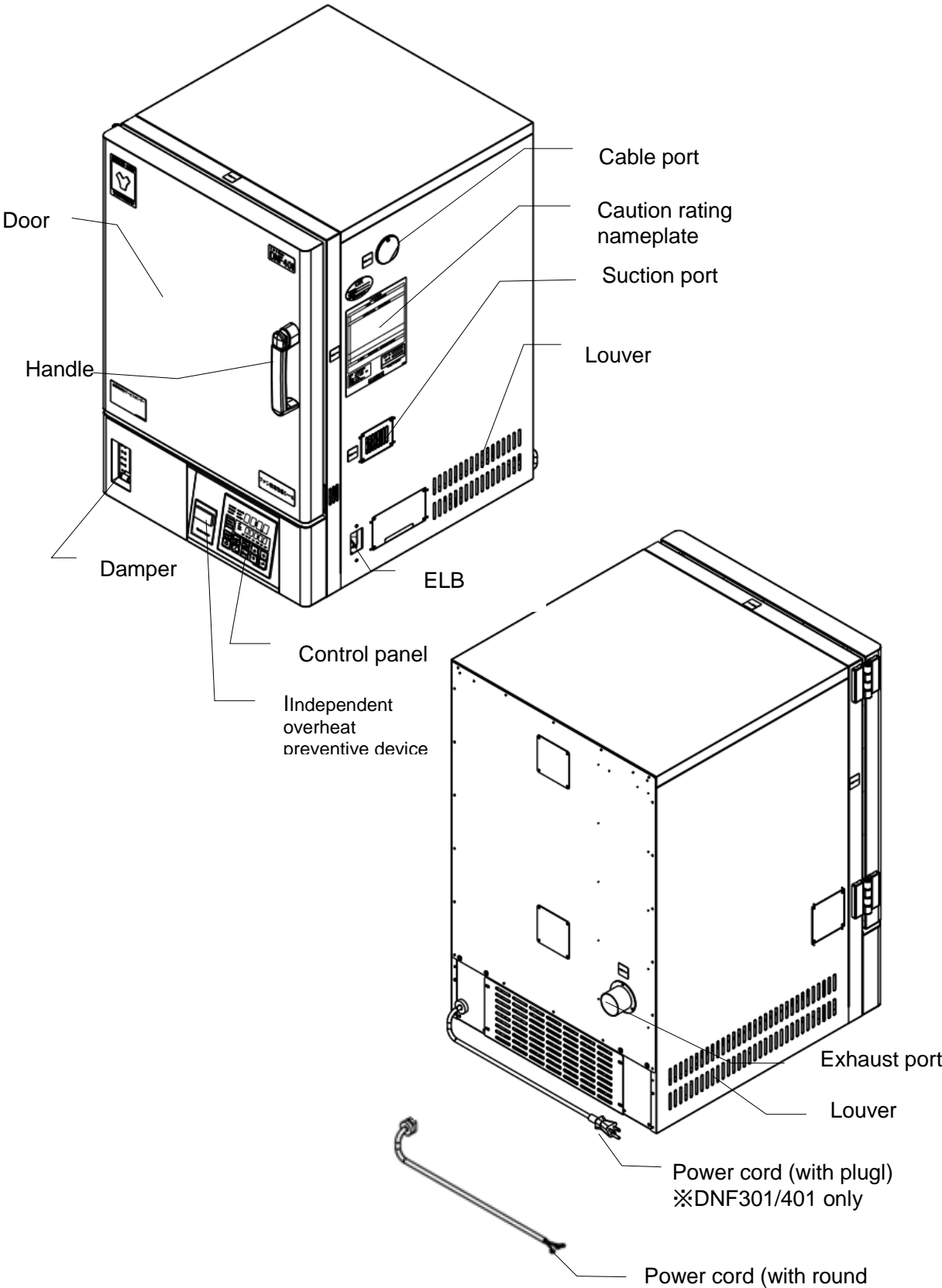

3. Names and functions of each part

System

The product has the variable wind-speed function. This function enables change of wind speed in 11 stages (FAN: 0 to FAN 10). At "FAN: 0", the fan stops completely. This mode is appropriate for the use of readily spattering sample. Its combination with the programmed operation function enables stepwise change of the wind speed. The fan can also be stopped at the end of operation.

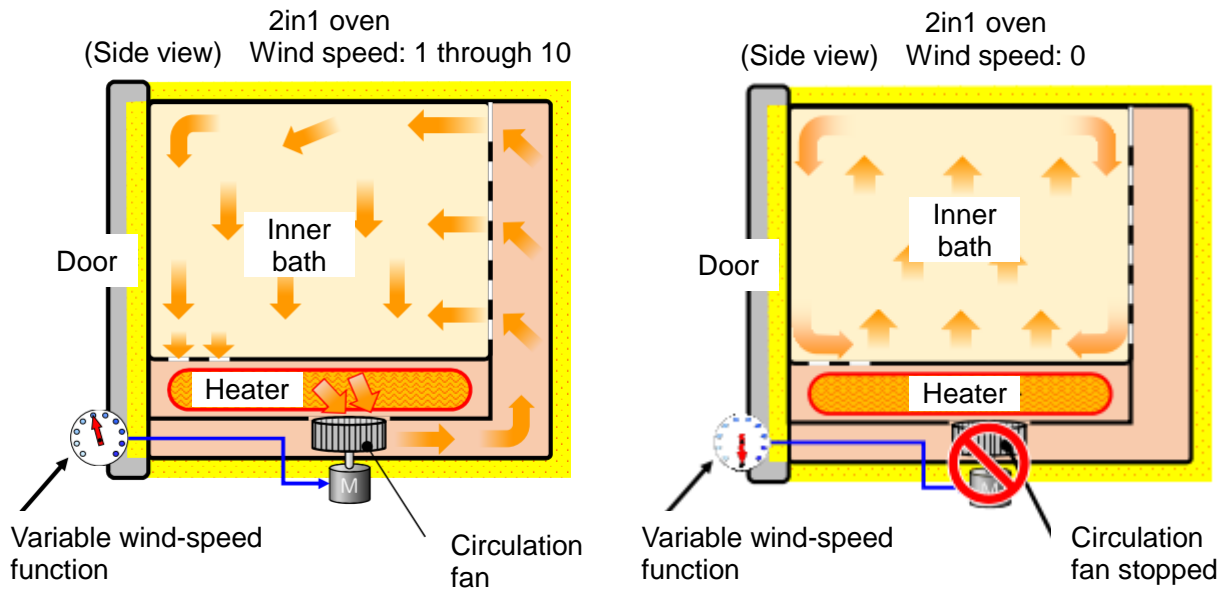

3. Names and functions of each part

Structure diagram

This product has the damper function.

The damper mechanism can change the damper opening in five stages; 0~100. With the damper opening, the air is discharged from the inside through the exhaust port. This function is appropriate for efficient sample drying by changing the internal air or for rapid lowering of the internal temperature. Adjust the damper opening according to the purpose.

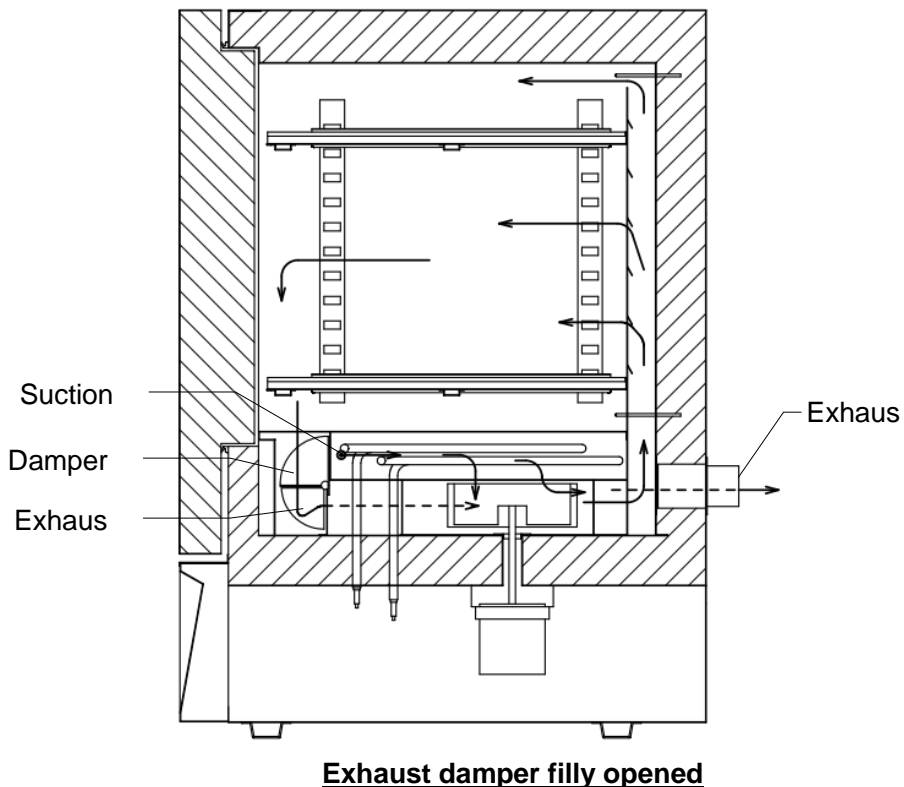
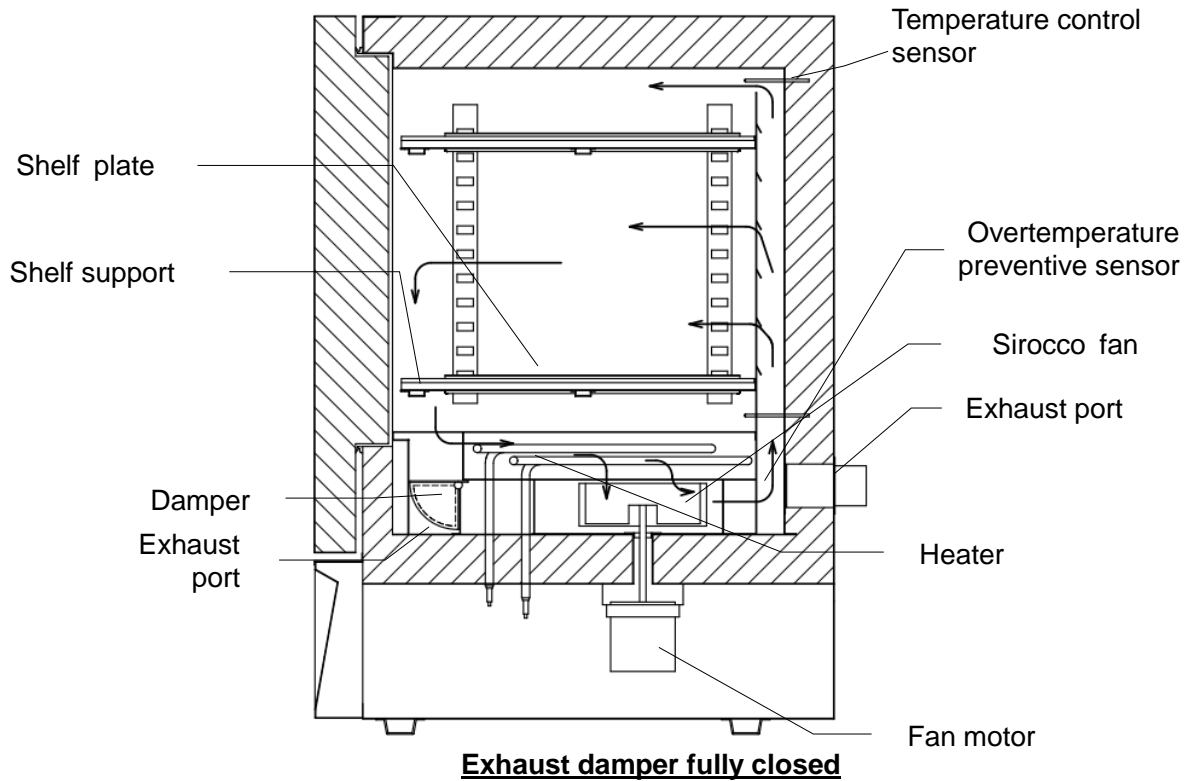

3. Names and functions of each part

Control Panel

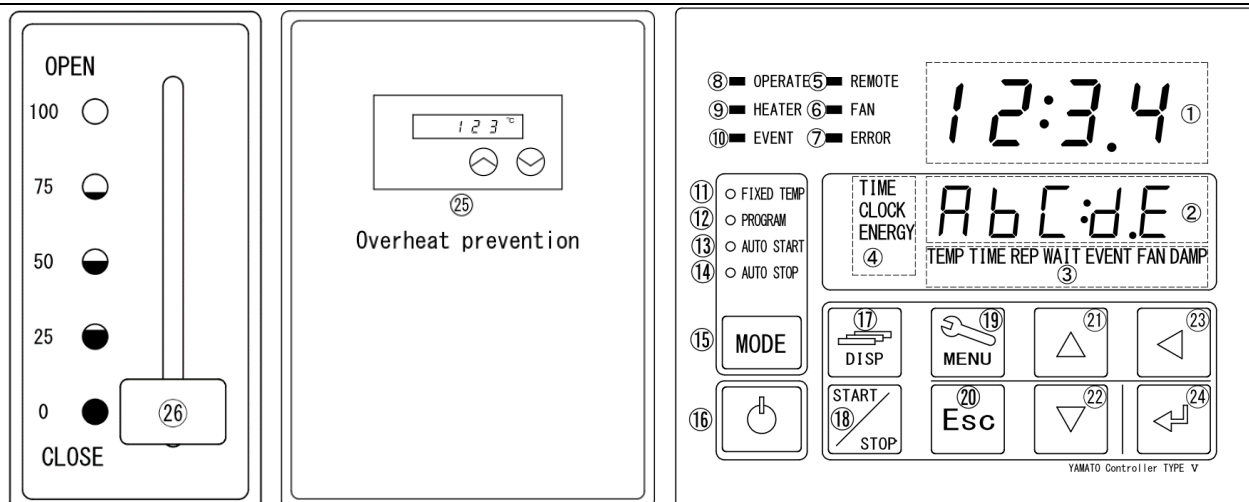

No.	Name	Description
1	Top screen	Display read temperature in Chamber and error numbers.
2	Bottom screen	Display target temperature and various information.
3	Program setting item display	Illuminate one of lamps selected from different settings.
4	Comes on during duration/time setting and in the Monitoring mode	Illuminate one of lamps selected from 3(three) different settings.
5	REMOTE Lamp	Illuminate during control via communication
6	FAN Lamp	Illuminate this Lamp while fan motor is in operation
7	ERROR Lamp	Illuminate this Lamp at each error occurred.
8	OPERATE Lamp	Illuminate this Lamp during operation, and flash it during operation standby mode.
9	HEATER Lamp	Flashes or lights while the heater is live according to the operation amount.
10	EVENT Lamp	Illuminate this Lamp at Event Output setting(option).
11	FIXED TEMP Lamp	Illuminate while the fixed temperature operation mode is selected.
12	PROGRAM Lamp	Illuminate in the Program operation mode.
13	AUTO START Lamp	Illuminate in the Auto start mode.
14	AUTO STOP Lamp	Illuminate in the Auto stop mode.
15	MODE key	Use at changing Operation Mode among No. 10 thru. No.13(10~13 on the Panel).
16	Controller POWER key	Turn "Idle State"-(Controller is sleeping) or "Standby State"-(Controller is awaking) of Keys(except 18MENU Key) by pressing and holding this key.
17	DISP key	Keep this key pressed longer to execute the Monitoring function. This key functions as the back key for setting items while any of setting menus displayed.
18	START/STOP key	Use to start selected operation or to stop working operation.
19	MENU key	Use to set target program, click on/off, output temperature range(option), and etc.
20	Esc key	Use to abort or get out of working menu without entering and/or editing set value and items.
21	▲(Up) key	Use to change set value up.
22	▼(Down) key	Use to change set value down.
23	◀ key	Used as the Left key for the setting digits (cursor) during setting.
24	ENTER key	Use to enter set value and items.
25	Independent overheat preventive device	Used for setting an operating temperature of the independent overheat preventive device.
26	Damper knob	Knob to adjust the opening of exhaust damper

4. Operating procedure

Prior confirmation

1. Check the power supply and the ground wire.



Make sure to connect with this Equipment Power Cord/Power Cable to appropriate power source and to ground definitely.

2. Check the ELB.



Check if the ELB functions properly.
See "Maintenance method" on P.61.
Check ELB performance once a month or before continuous long-term operation.
※Tick current time on Bottom Screen of Control Panel at ELB ON(|).

3. Check the Independent Overheat Preventive device.



Make sure to set IOPD temperature more than 30°C higher of Target Temperature in Chamber.
Check IOPD performance before continuous long-term operation. Refer to "Independent Overheat Prevention Device" on page 52.

4. Check the opening of exhaust damper.



Check if the damper is opened to the required degree. Close the damper during operation when ventilation is not required.

4. Operating procedure

Date & Time setting

The controller of this product keeps backup memory for customer settings including the calendar, timer settings, or operation programs using the built-in battery. This battery will hold data for about five years even if you turn power of the unit off. (Battery life will change depending on specific operating conditions.)

- ※ Contact with Yamato local dealer or Yamato Customer Service Center in case of replacing this battery. Make backup data file of the existing program data in case of being processed program mode. See “Backup data saving/reading out/resetting” on page 52.

Set up date & time properly in accordance with local time after replacing with new battery.

1 Turn on power.

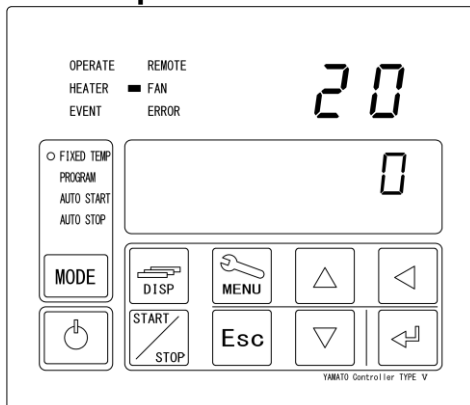

Turn on (|) Earth Leakage Breaker(ELB) on the right side of this Equipment.

Bottom Screen of the controller indicate clock time. This is “**Idle State**” of this Equipment.

Press and hold  key to display standby screen. This is “**Standby State**” of this Equipment.

Indicate read temperature in Chamber on Top Screen and indicate target temperature on Bottom Screen.

The fan motor will start.

The fan motor operates when the door is open and it stops when you open the door.

2 Display year/month/date and time on each Screen by MENU key.

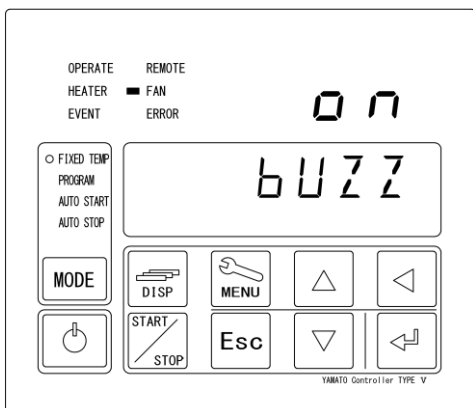

- ① Press key.
- ② Press key few times until [FUNC] is indicated on Bottom Screen and then press key.
- ③ Press key to display year on Top Screen and month/date/time on Bottom Screen, When Bottom Screen show [BUZZ].

The key can be used to reverse the process.

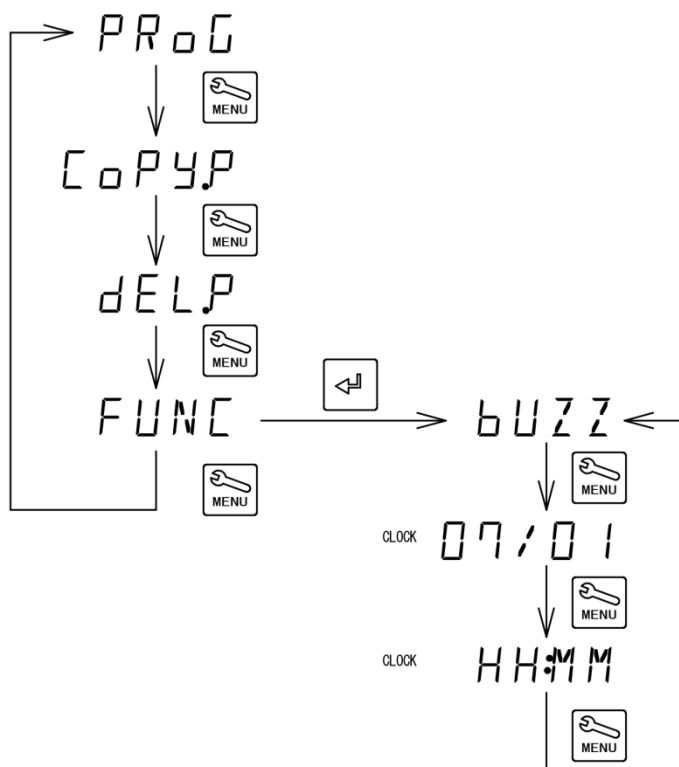

4. Operating procedure

Date & Time setting

3 Set up year and month/date.

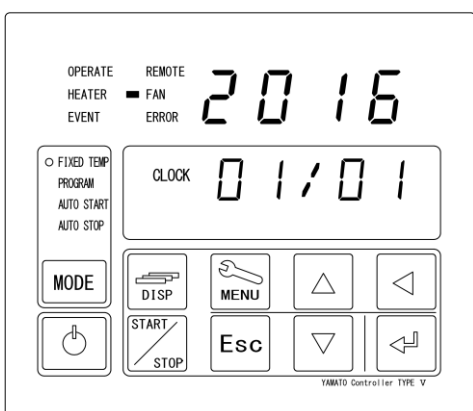

Set up year/month/date and clock time.

- ① Flash CLOCK lamp. Year and month/date are displayed on Top and Bottom Screen respectively.
- ② Press key.
- ③ Set calendar year with keys and then press key.
- ④ Set month/date with keys and then press key.

※ Press key to shift setting position.

4 Set up clock time (described according to 24-hour time).

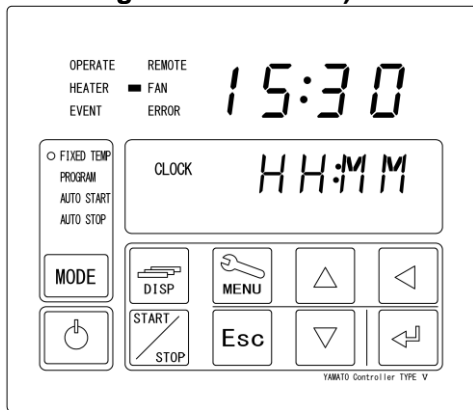

- ① Press key.
- ② Press key, set clock time with keys, and then press key.
Enter clock time in accordance with 24-hour time.
※ Press key to shift setting position.
- ③ Press key twice to get back to initial screen after completion of those settings.

Buzzer function selection

1 Select buzzer function.

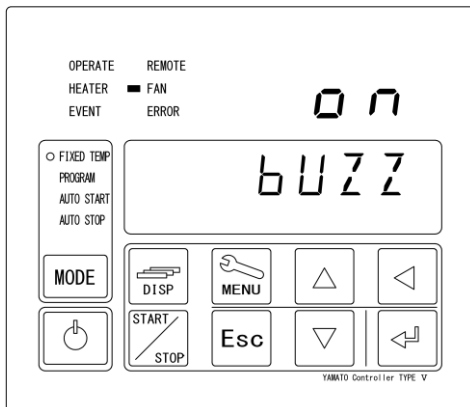

- ① Press key and key to display [bUZZ] on Bottom Screen with same process of clock time setting described in [2], and then press key.
 - ② Select one from three types of buzzer function with keys and then press key.
 - ON: Activate clicking sound for all keys and beeping sound for alarm. (Set "on" initially at Factory shipment)
 - CLF :Activate only clicking sound for "Controller POWER key and ENTER key", and beeping sound for alarm.
 - OFF: Deactivate clicking sound for all keys.
- ※ The buzzer will sound when an error occurs even if you set "bUZZ" to a setting other than ON.
- ③ Press key twice to get back to initial screen after completion of those settings.

4. Operating procedure

Operating procedure

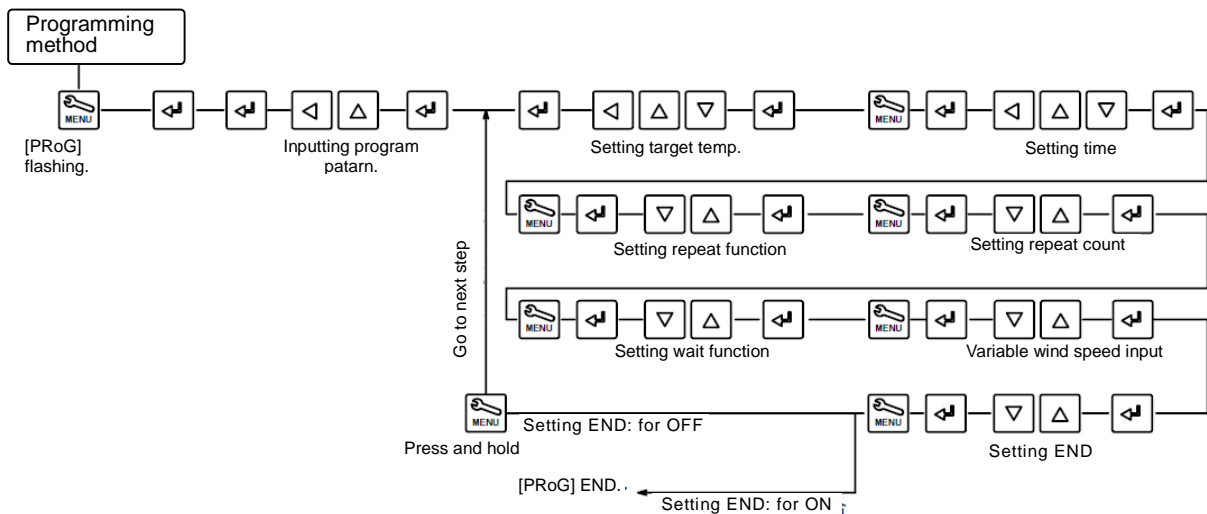
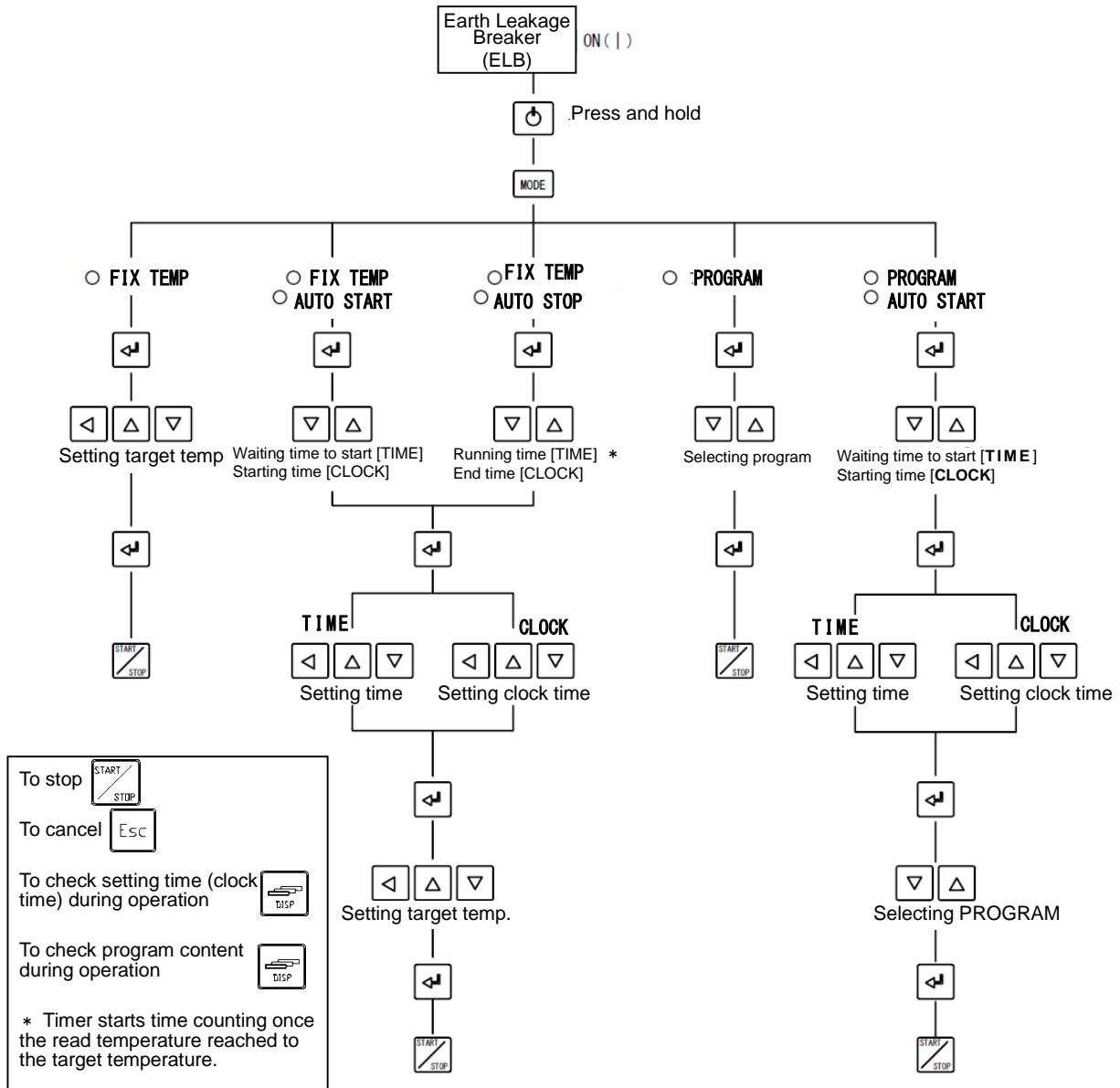

4. Operating procedure

Fixed temperature operation

FIXED TEMP(Fixed Temperature) mode is to keep running at target temperature. It will keep running until operation stops.

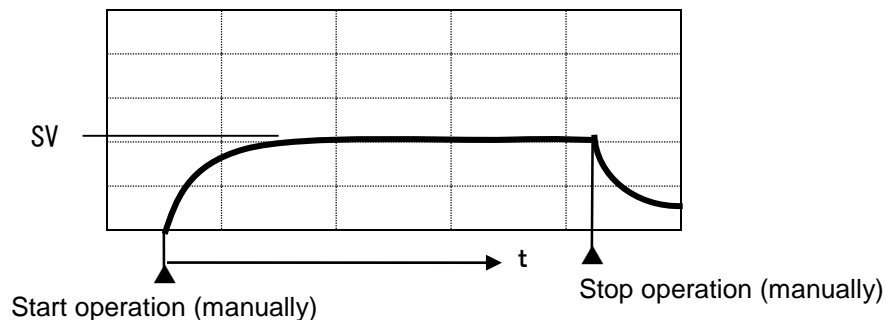

SV: Set Value (Target Temperature), t : Time

Set Fixed Temperature mode.

1 Turn on the controller.

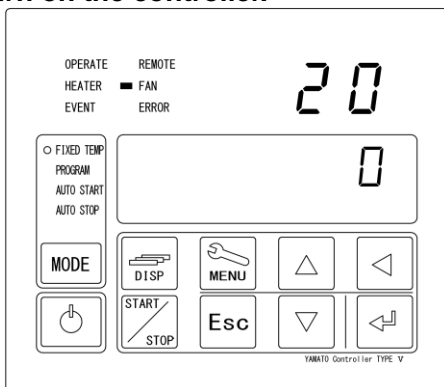

Turn on Earth Leakage Breaker(ELB) on (|) the right side wall of this Equipment. (Idle State)

Press and hold key to turn on the controller power. (Standby State)

Indicate read temperature in Chamber on Top Screen and indicate target temperature on Bottom Screen.

The fan motor will start and FAN lamp illuminates.※1

The fan motor operates when the door is closed and stops while the door is open. ※2

※1, ※2「 The case with "FAN:S" set to "0" is excluded.

For details, refer to "Use of variable wind speed, method of entry," on P28,29.

2 Select Fixed Temperature Operation.

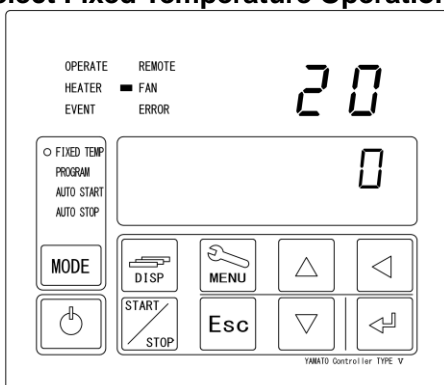

Press key to turn FIXED TEMP (Fixed Temperature mode) lamp on.

※ Fixed Temperature mode would be selected at first time operation. After that, most latest operated mode is selected.

3 Set target temperature.

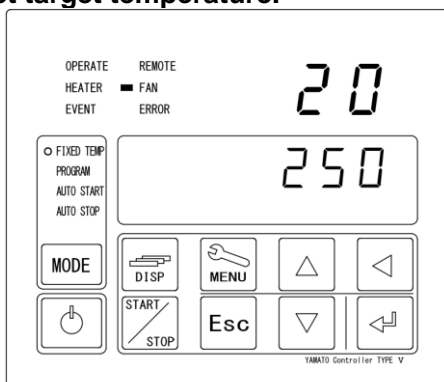

① Press key. Then flash changeable digits on Bottom Screen.

② Shift to flashing digit with key and then change to desired digit with keys.

Operating Temp. Range:0~130°Q(Natural convection)

0~270°Q(Forced wind)

③ Press key when target temperature setting has completed.

Press key once or twice to cancel its setting.

4. Operating procedure

Fixed temperature operation

4 Starting operation

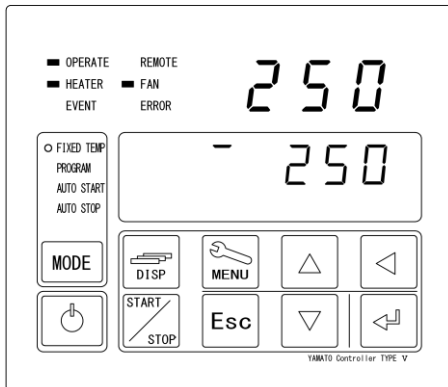
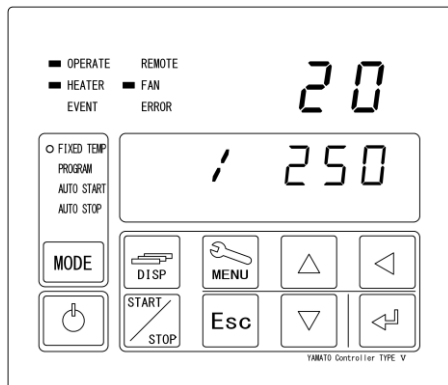

Use the  key to start operation.

The OPERATE (operating) lamp and the HEATER (heater) lamp will come on and temperature control starts.

※ Bottom screen during heating

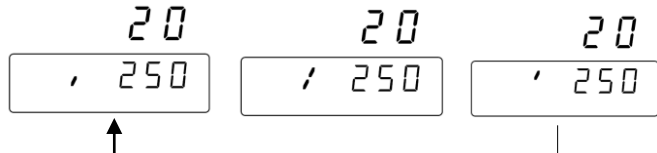

※ Bottom screen while temperature is stable

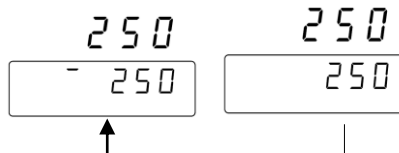

※ Bottom screen while temperature is decreasing

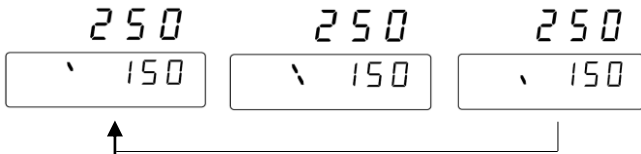

5 Stopping operation

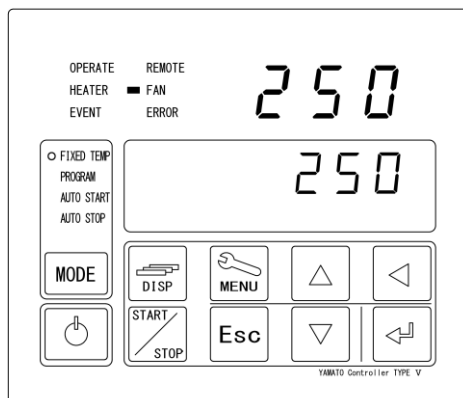

Use the  key to manually stop operation.

The screen will return to the one before starting operation when you stop operation.

※ The fan motor keeps operating even operation is stopped. Press the  key longer to turn the controller power off to stop the fan motor.

4. Operating procedure

Fixed temperature operation

6 Stop running Fixed Temperature Operations with timer setting. (Quick Automatic Stop Function)

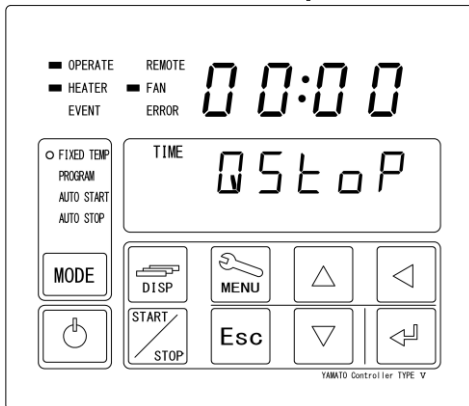

Quick Automatic Stop Function is to stop automatically running Fixed Temperature Operation.

- ① Press **MODE** key at running Fixed Temperature operation.
- ② Show **[QSTOP]** on Bottom Screen and start **[TIME]** lamp flashing on the left top of Bottom Screen.
- ③ Select the method to stop from **TIME/CLOCK** with **△** **▽** key and then press **↵** key.
- ④ Set **TIME** (capable setting range: 0~99hr : 59min) or **CLOCK** (according to 24-hour time) on Top Screen and then press **↵** key.

Example 1. Setting time to stop:

Operation is stopped automatically in 35 hours and 30 minutes once temperature reached to target temperature.

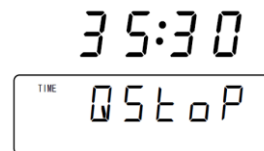

Example 2. Setting clock time to stop:

Operation is stopped automatically at 15:00.

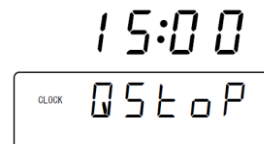

- ⑤ The **AUTO STOP** (Auto Stop) lamp comes on and the Auto Stop function starts.

※ You can use the **DISP** key to check the remaining operation time/stop time information on the Bottom screen.

※ Screen to check the remaining operation time

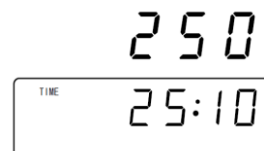

※ Screen to check the operation stop time

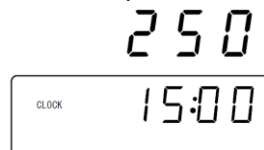

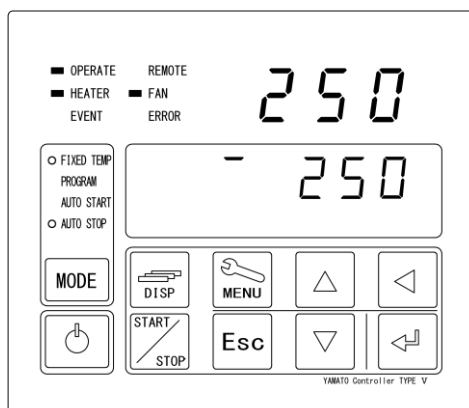

Press the **DISP** key again or wait for about 10 seconds to return to the original status.



4. Operating procedure

Fixed temperature operation

<p>OPERATE REMOTE HEATER FAN EVENT ERROR</p> <p>25.0</p> <p>END</p> <p>○ FIXED TEMP PROGRAM AUTO START ○ AUTO STOP</p> <p>MODE</p> <p>DISP MENU</p> <p>START STOP Esc</p> <p>YABATO Controller TYPE V</p>	<p>⑥ When the set time duration elapses or the time comes, the Bottom screen will indicate [END] and operation will stop.</p> <p>⑦ Use the  key to eliminate the [END] indication.</p>
<p>OPERATE REMOTE HEATER FAN EVENT ERROR</p> <p>12.5</p> <p>25.0</p> <p>○ FIXED TEMP PROGRAM AUTO START ○ AUTO STOP</p> <p>MODE</p> <p>DISP MENU</p> <p>START STOP Esc</p> <p>YABATO Controller TYPE V</p>	<p>※ When you stop operation, the screen will return to the one before starting operation.</p> <p>※ The fan motor keeps operating after operation has been stopped. Press the  key longer to turn the controller power off to stop the fan motor.</p>

4. Operating procedure

Auto stop operation

This operation mode is used to automatically stop operation by setting the timer.

The operation mode where operation is automatically stopped by setting an operation duration.(when you set an operation duration)

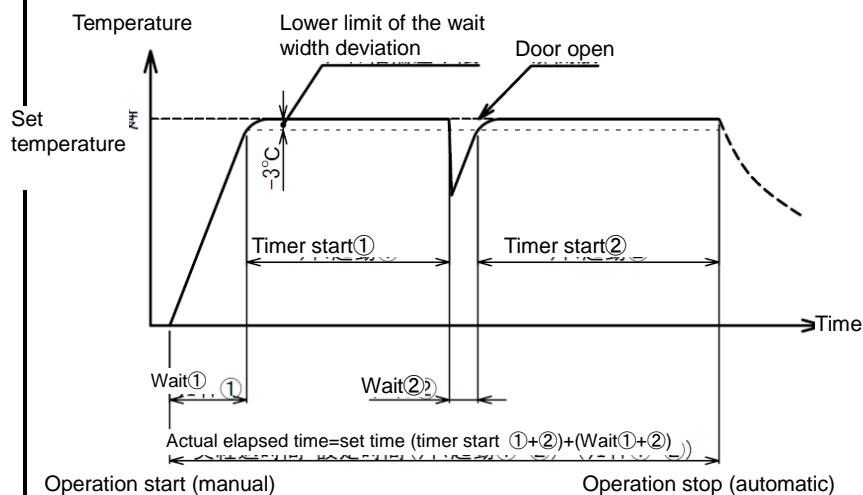

※ When you set a time, the wait function will be activated, the mode will remain “waiting” without counting down the time until temperature indication will be within the wait deviation range between -3°C and $+6^{\circ}\text{C}$ to the set temperature. Counting down starts when the temperature in the chamber reaches the temperature -3°C (indication) to the set temperature.

Even if the temperature in the chamber (indication) the mode will be “waiting” if the lower limit of the wait width deviation is exceeded and time counting down will not occur until the temperature in the chamber (indication) returns.

Operation mode where operation stops automatically at the set time (when an operation time is set)

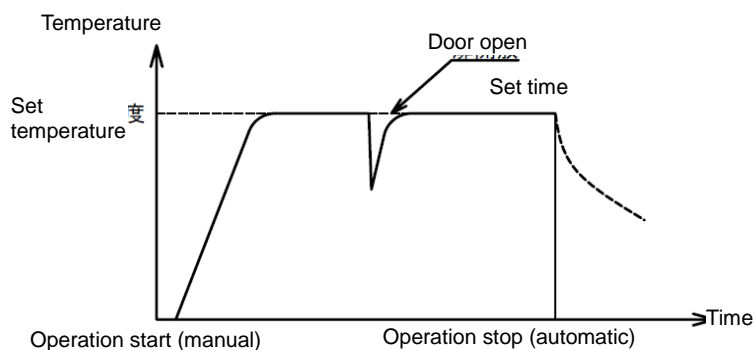

※ The wait function will not work if you select a time setting. Operation will stop when the set time comes. The time you can set is up to 24 hours from the present time.

When a power failure occurred before the set time and continued after that and then the unit recovered automatically, operation will continue to the next set time so remember to stop operation manually.

Set Automatic Stop mode

1 Turn on the controller

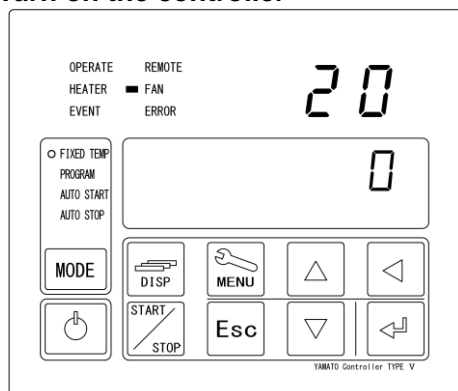

Turn on (|) Earth Leakage Breaker (ELB) on the right side wall of this Equipment. (Idle State)

Press and hold  key to turn on the controller power.

Indicate circulating liquid temperature in Chamber on Top Screen and indicate target temperature on Bottom Screen.

The fan motor will start.

The fan motor operates when the door is closed and stops while the door is open.

4. Operating procedure

Auto stop operation

2 Selecting Automatic stop Operation

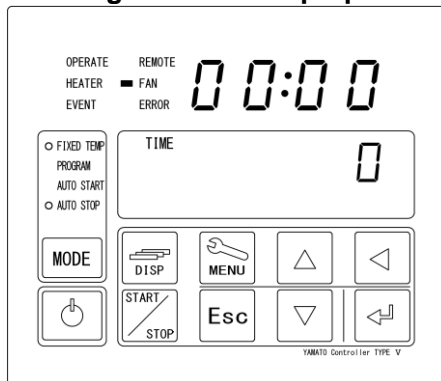

Press **MODE** key to turn FIXED TEMP (Fixed Temperature mode) and AUTO STOP (Automatic Stop mode) lamp on.

※ Fixed Temperature mode would be selected at first time operation. After that, the latest operated mode is selected.

3 Set target temperature and operation running time / clock time to stop.

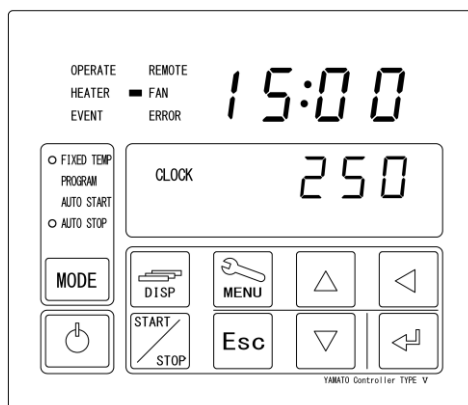
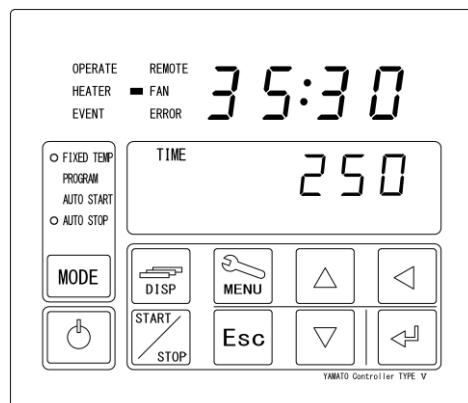

① Press **←** key.

Select stop method from TIME/CLOCK with **△** **▽** keys and then press **←** key.

② Set TIME (capable setting range: 0~99hr : 59min) or CLOCK (according to 24-hour time) on Top Screen and then press **←** key.

③ Set target temperature on Bottom Screen and then press **←** key.

Example 1. Setting running time:

Operation is stopped automatically in 35 hours and 30 minutes once temperature reached to 250 °C of target temperature.

Example 2. Setting clock time to stop:

Start operation and reach to 250°C in Chamber of target temperature, and operation is stopped automatically at 15:00.

4. Operating procedure

Auto stop operation

4 Starting operation

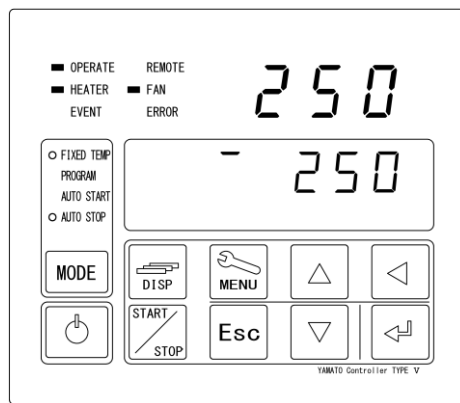
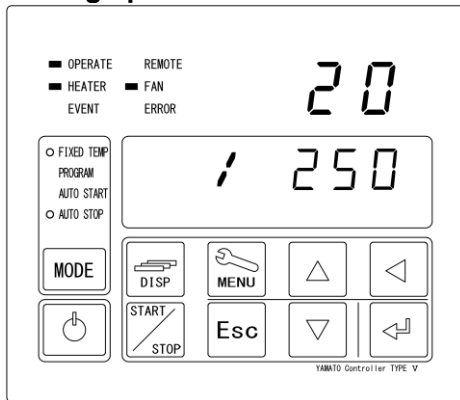

- ① Use the  key to start operation.

The OPERATE (operating) lamp and the HEATER (heater) lamp will come on and temperature control starts.

- ※ You can use the  key to check the remaining operation time/stop time information on the Bottom screen.

- ※ Screen to check the remaining operation time

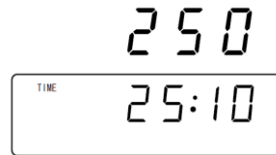

- ※ Screen to check the operation stop time

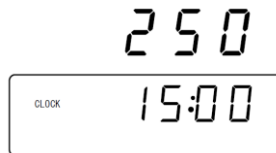

Press the  key again or wait for about 10 seconds to return to the original status.

5 Cancelling operation

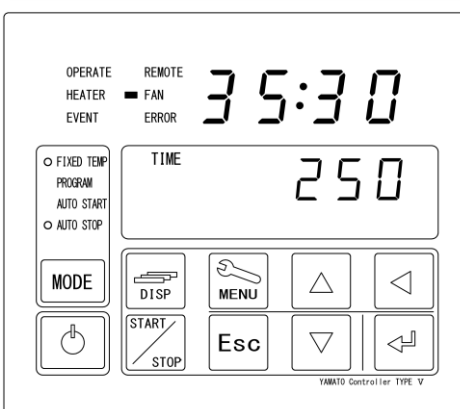
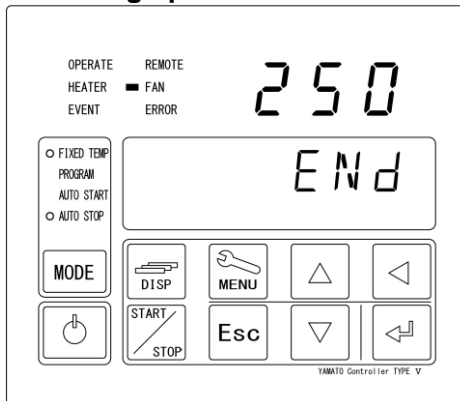

- ① When the set time duration elapses or the time comes, the Bottom screen will indicate [END] and operation will stop.

- ② Press the  key to eliminate the [END] indication.

- ※ When you stop operation, the screen will return to the one before starting operation.

- ※ The fan motor keeps operating after operation has been stopped. Press the  key longer to turn the controller power off to stop the fan motor.

4. Operating procedure

4. Operating procedure

AUTO START (Automatic Start) mode is to start operation automatically with timer. This operation does not stop automatically once its start. Stop manually, if required.

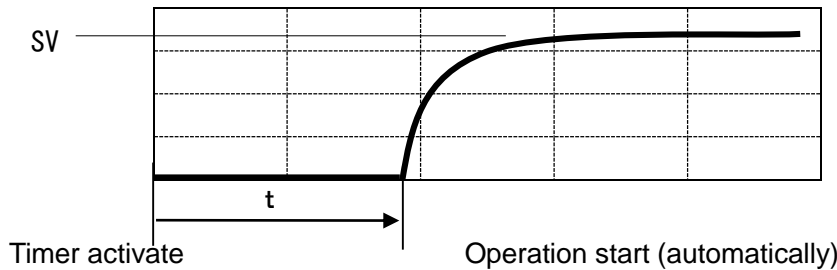

SV ; Target temperature t ; Auto start setting time (time)

Set Automatic Start mode

1 Turn on the controller.

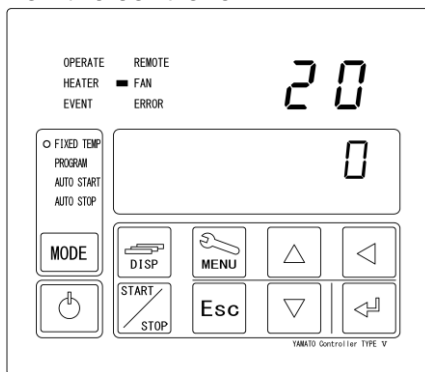

Turn on (|) Earth Leakage Breaker(ELB) on the right side wall of this Equipment. (**Idle State**)

Press and hold key to turn on the controller power. (**Standby State**)

Indicate circulating liquid temperature in Chamber on Top Screen and indicate target temperature on Bottom Screen.

The fan motor will start.

The fan motor operates when the door is closed and stops while the door is open.

2 Select Automatic Start mode

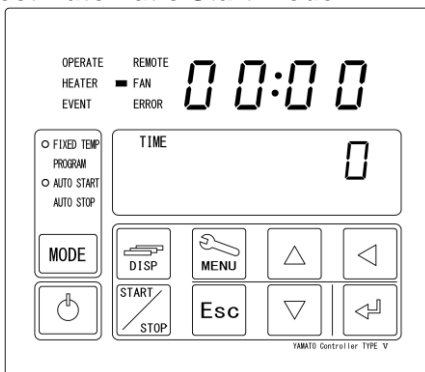

Press key to turn FIXED TEMP (Fixed Temperature mode) and AUTO START (Automatic Start mode) lamp on.

※ Fixed Temperature mode would be selected at first time operation. After that, the latest operated mode is selected.

3 Set target temperature and operation wait time / clock time to start.

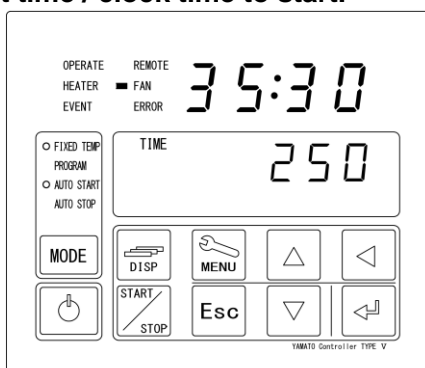

① Press key.

Select start method from TIME/CLOCK with

keys and then press key.

② Set TIME (capable setting range: 0~99hr : 59min) or CLOCK (according to 24-hour time) on Top Screen and then press key.

③ Set target temperature on Bottom Screen and then press key.

4. Operating procedure

Auto start operation

Example 1. Setting wait time to start:

Press  key to count timer for 35 hours and 30 minutes, and then start automatically operation to reach to 250°C of target temperature in

35:30

TIME 250

Example 2. Setting clock time to start:



Press  key to start automatically operation to reach to 250°C of target at temperature at 15:00.

15:00

CLOCK 250

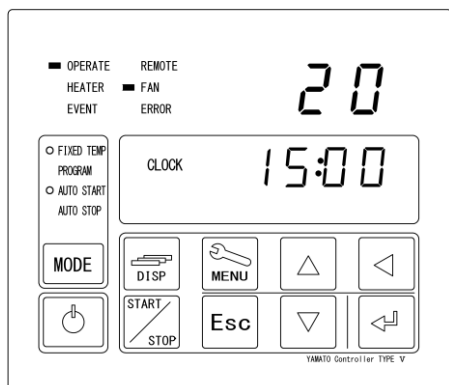
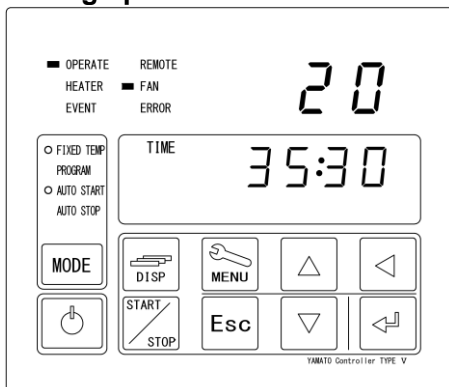
4 Starting operation



- ① Press  key to be standby mode for starting operation.
- ② Press  key to be standby mode for starting operation.

※ The Top screen shows the present temperature in the chamber while the Bottom screens shows the operation wait duration and the operation start time. When you have selected a wait time, counting down of the set time starts.

20

TIME 25:37

※ You can check the set temperature on the Bottom screen using the  key.

20

250

Pressing the  key again will make the Bottom screen show the operation wait duration and the operation start time.

4. Operating procedure

Auto start operation

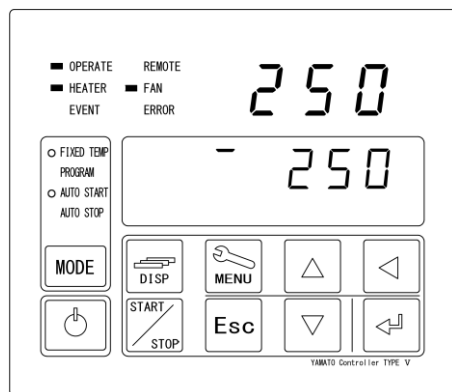
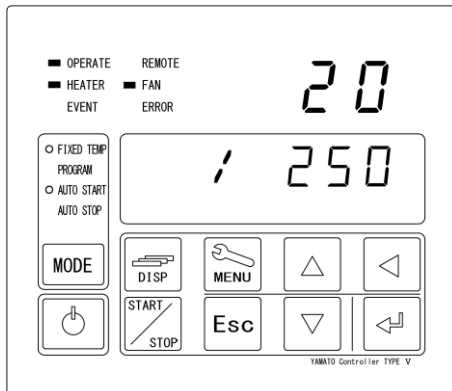



- ③ When the set time duration elapses or the time comes, the OPERATE (Operating) lamp will change its status from flashing to staying on as well as the HEATER (Heater) lamp comes on and temperature control will start.

※ You cannot use the Quick auto stop function for the Auto start operation.

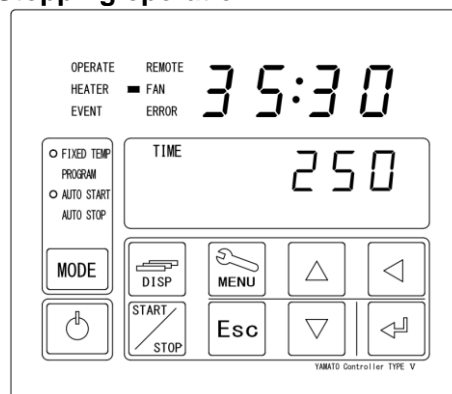
5 Stopping operation



Use the  key to manually stop operation. The screen will return to the one before starting operation when you stop operation.

※ The fan motor keeps operating even operation is stopped. Press the  key longer to turn the controller power off to stop the fan motor.

4. Operating procedure

Operation of the variable wind-speed function and the method of entry

The variable wind-speed function is convenient for operation while changing the ventilation rate and the internal wind speed.

The fan motor speed can be set in 11 stages; 0~10.

The wind speed setting of 1~9 may not be enough to achieve the specified temperature performance. It is recommended that the customer confirm by himself the applicability under each of conditions.

Setting the wind-speed variable value

1 Turn ON power supply to the controller.

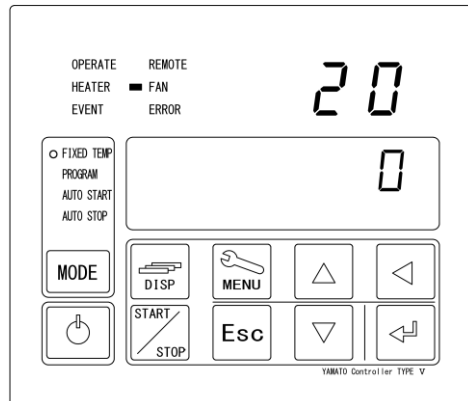

Turn ON the earth leakage breaker in the right-hand side of the main body. Keep pressing the  key, and the controller power supply is turned ON. The main display shows the internal temperature while the sub-display shows the set temperature. The fan motor starts running. The fan motor runs when the door is closed and stops when the door is opened.

2 Enter the wind-speed variable setting screen with the MENU key.

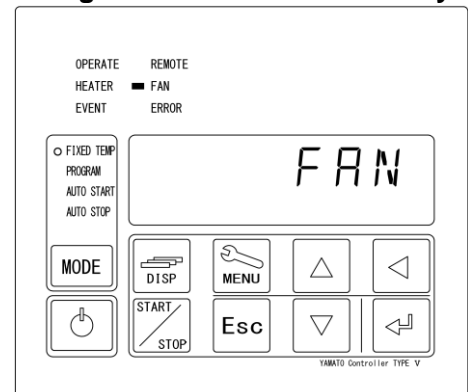



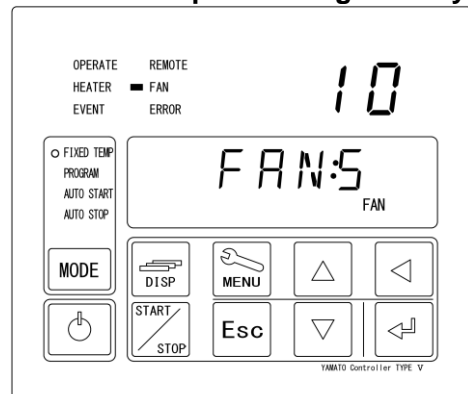

Press the  key several times to show the wind-speed variable setting screen "FAN" in the flashing manner in the sub-delay.

※ The wind-speed variable setting can be made even during operation.

3 Set the wind speed during standby.









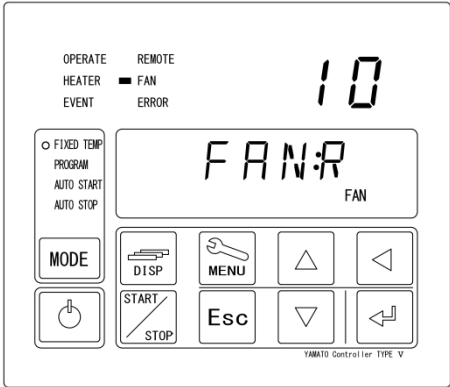

Press the  key, and "S" of the wind speed screen "FAN;S" during standby flashes. Enter the set value 0 through 10 of the main screen by using  and  keys. Acknowledge the entry with the  key.

※ Note that the set value "0" cannot be set when the set temperature exceeding 130°C has been set in any of constant-value, auto start, and auto stop operations.

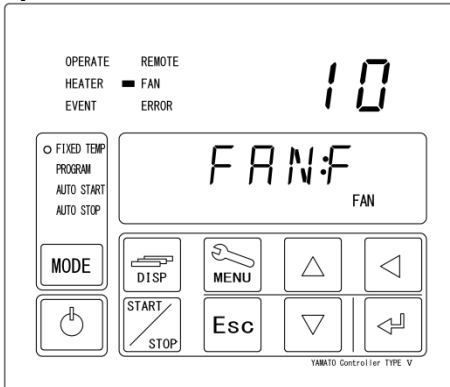
4. Operating procedure

Operation of the variable wind-speed function and the method of entry

<p>4</p>	<p>Setting the wind speed during operation.</p>  <p>The screenshot shows the controller's main screen. At the top left, there are indicators for 'OPERATE', 'REMOTE', 'HEATER', 'FAN', 'EVENT', and 'ERROR'. The 'FAN' indicator is active. The top right displays the number '10'. The center of the screen shows 'FAN:R' with 'FAN' below it. Below the screen is a control panel with buttons for 'MODE', 'DISP', 'MENU', 'START/STOP', 'Esc', and directional arrows (up, down, left, right).</p>	<p>During operation, “R” of “FAN:R” in the wind speed screen flashes.</p> <p>Enter “0 to 10” in the main screen with  and  keys and acknowledge with the  key.</p> <p>※Note that the set value “0” cannot be set when the set temperature exceeding 130°C has been set in any of constant-value, auto start, and auto stop operations.</p>
<p>5</p>	<p>Setting the wind speed at end of operation</p>  <p>The screenshot shows the controller's main screen. At the top left, there are indicators for 'OPERATE', 'REMOTE', 'HEATER', 'FAN', 'EVENT', and 'ERROR'. The 'FAN' indicator is active. The top right displays the number '10'. The center of the screen shows 'FAN:F' with 'FAN' below it. Below the screen is a control panel with buttons for 'MODE', 'DISP', 'MENU', 'START/STOP', 'Esc', and directional arrows (up, down, left, right).</p>	<p>At end of operation, “F” of “FAN:F” in the wind speed screen flashes.</p> <p>Enter “0 to 10” in the main screen with  and  keys and acknowledge with the  key.</p> <p>Press the  key twice, and the standby screen is reset to the “Operating” screen (namely reset to the screen just before entry in the menu screen).</p> <p>※Note that the set value “0” cannot be set when the set temperature exceeding 130°C has been set in any of constant-value, auto start, and auto stop operations.</p>
<p>6</p>	<p>Determining the wind speed for programmed operation.</p>	<p>The wind speed for programmed operation can be set at the END step.</p> <p>※ The set value for #FAN:F” in this setting screen is not applicable as the FAN speed value at end of programmed operation.</p>

4. Operating procedure

Program operation

PROGRAM mode is to run programmed cycle such as figure below.

Target temp.

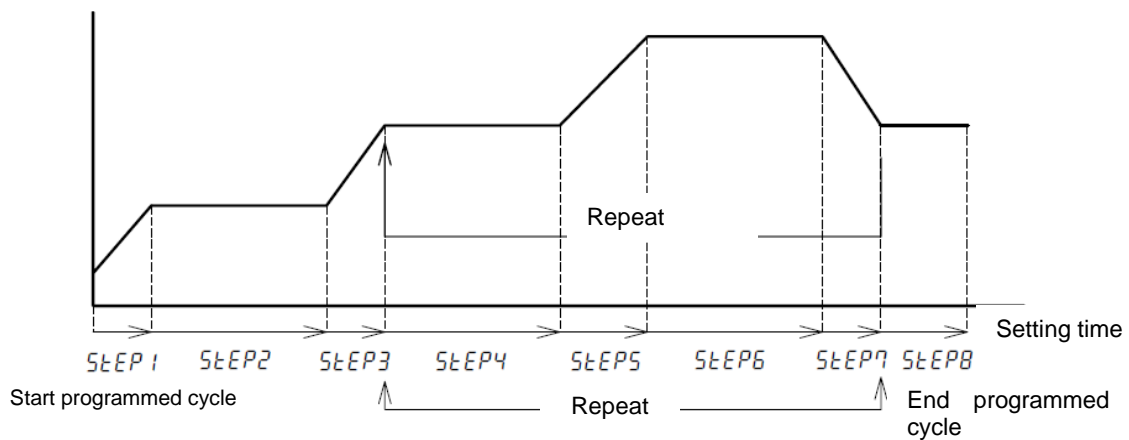

Setting the program operation

1 Turning on the controller

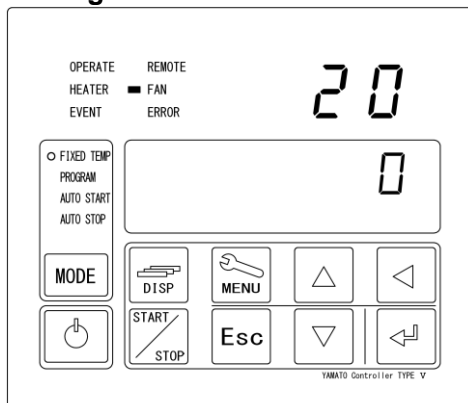

Turn the ELB on the right side of the main unit[ON(|)]. Pressing the key longer will turn the controller power on.

The Top screen shows the temperature in the chamber while the Bottom screen shows the set temperature.

The fan motor will start.

The fan motor operates when the door is open and stops when the door is opened.

* Register target program prior to start running cycle at first.

For how to register a program, see “P.34 Programming method”.

Create as many as steps up to 99 at maximum and save programmed pattern data up to 99 in total.

(For example: 11 program patterns will be stored at maximum, if each pattern is programmed 9 steps. The number of steps in the repeat interval will be the number of the steps set in the registration part irrespective of the number of repetitions.)

2 Select program mode

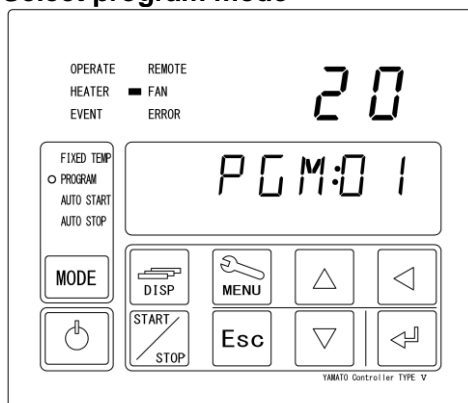

Press key to turn PROGRAM Lamp on.

The bottom screen shows [PGM:01] ([01] indicates a program you used in the last session.)

※ Fixed Temperature mode would be selected at first time operation. After that, the latest operated mode is selected.

4. Operating procedure

Program operation

3 Select program patter number

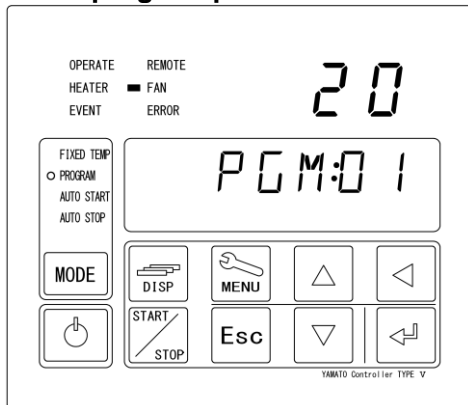

Press key. 01, a part of [PGM:01], is flashing on Bottom Screen. Select particular number of desired program pattern with keys and then press key.

4 Start program mode

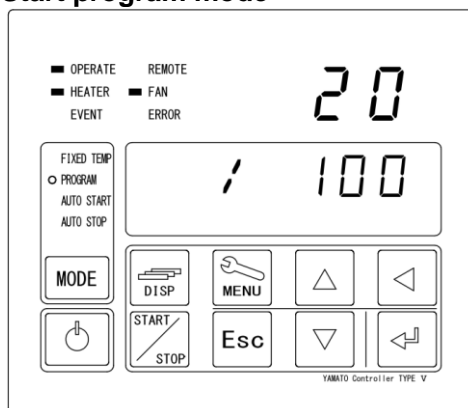

Press key to start programmed cycle operation.

- ※ Never run its cycle if [END] is not set at the end step in the program. Check again that program setting, if cycle do not start.
- ※ You can check the program pattern number, the step number or the remaining operation time being executed on the Bottom screen with the key during operation.
- ※ Screen to check the number of a program pattern being executed.

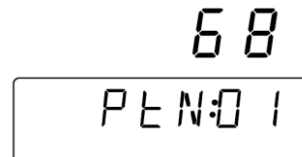

- ※ Screen to check the number of a program step being executed.

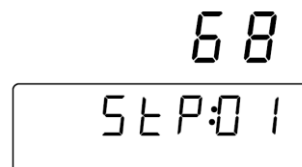

- ※ Screen to check the remaining time of a step being executed.



4. Operating procedure

Program operation

5 Cancelling program operation

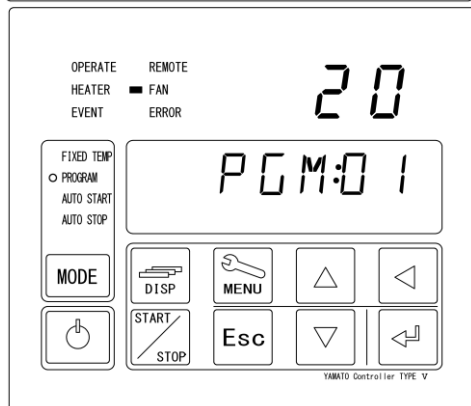
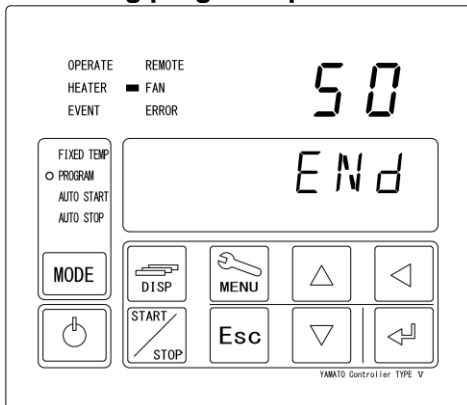

① When the set program ends, the Bottom screen shows [END] and operation will stop.

② You can eliminate the [END] indication using the  key.

※ For the wind speed setting when the “END” display has been canceled, refer to the operation of variable wind-speed function and the method of entry (P.29 and 30).

4. Operating procedure

Programming Method

Sample program setting

In this example, 8 steps are registered in the program pattern 2, steps from 4 to 7 will be repeated 5 times and the whole session will end at the step 8.

Note: Steps 4 to 7 will be repeated 6 times.

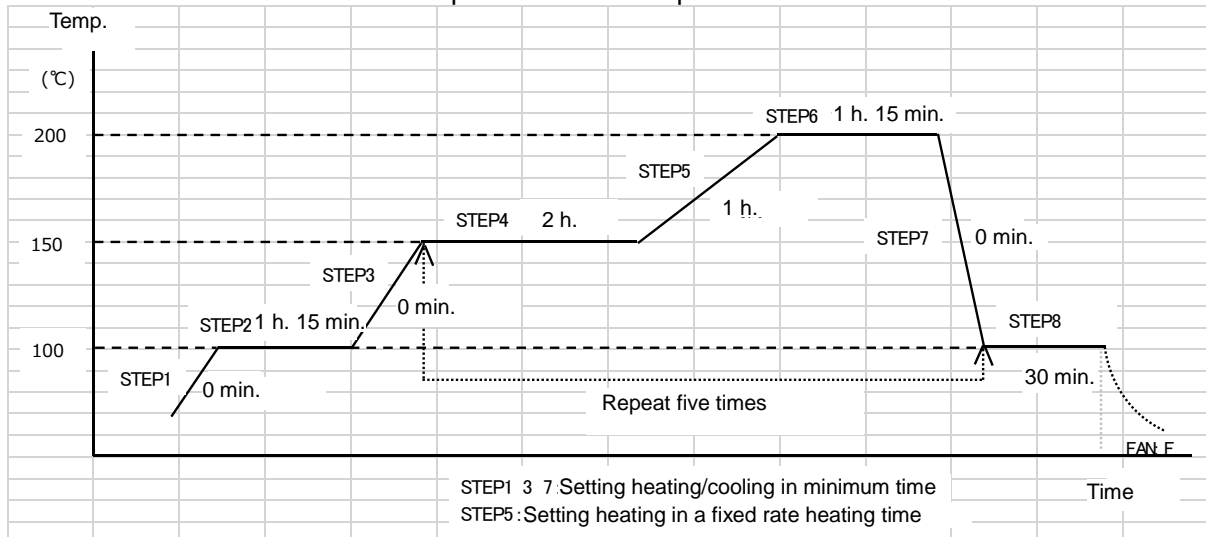

Pattern No	Step	Set temp.	Set time	Repeat dstn.	Repeat No.	Wait	Wind speed in operation	End	Wind speed at end
P*	P02:	TEMP	TIME	REP(STEP)	REP(COUNT)	WAIT	FAN	ENDST	FAN
*:01	**								
02	01	100	00:00	0	0	ON	10	OFF	-
	02	100	01:15	0	0	OFF	10	OFF	-
	03	150	00:00	0	0	ON	10	OFF	-
	04	150	02:00	0	0	OFF	10	OFF	-
	05	200	01:00	0	0	ON	10	OFF	-
	06	200	01:30	0	0	OFF	10	OFF	-
	07	100	00:00	4	5	ON	0	OFF	-
	08	100	00:30	0	0	OFF	0	ON	0

※ When time settings on heating or cooling steps are beyond the heating or cooling capacity (0 minutes in steps 1, 3 & 7 above) of the unit, it will operate at full power for a short time in wait (ON) mode until temperature setting has been reached. With wait set to OFF, unit will proceed to the next step regardless of whether temperature setting has been reached. Use caution when setting short heating/cooling times.

※ When the time setting on heating or cooling steps is set longer than unit normally takes build heat or cool, unit will adjust itself to do so within the set timeframe.

※ When a fixed temperature step is set and wait is [ON], the wait mode will continue from the time when the temperature in the bath drops below the lower limit of the wait width deviation temperature due to, for example, opening of the door until the temperature in the bath will recover above that lower limit. At [OFF] the process will proceed to the next step after the set time irrespective of changes of the temperature in the bath.

※ When you use the repeat function, program the operation so that the set temperature before shifting to the repeat mode will be the same as the set temperature of the destination of repetition.

※ Checking the heating capacity and the cooling capacity before setting is encouraged since these will differ depending on the environmental temperature and the operating conditions.







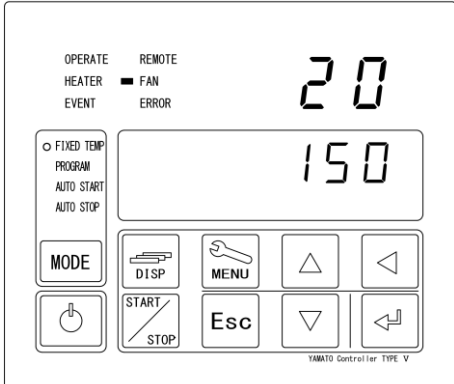

※

When the setting of wind speed at "0" is effective, wind-speed setting may be restricted depending on the set temperature. (DNF301/401/411/601/611)

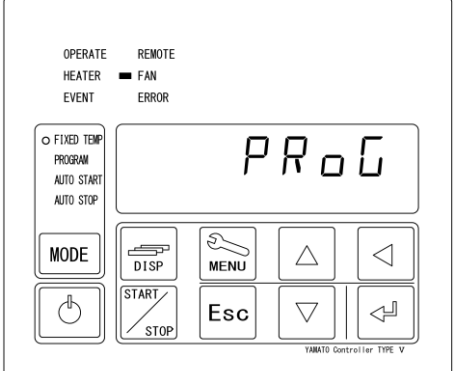
- ex) The wind speed may be set at 1 through 10 when the set temperature is above 130°C.**
The wind speed may be set at 0 through 10 when the set temperature is 130°C or below.
Please note that, when the wind speed is set at 0 at 130°C or below in the step next to the setting at above 130°C, the operation allows the temperature to lower through natural cooling to 130°C instead of lowering at a constant rate.

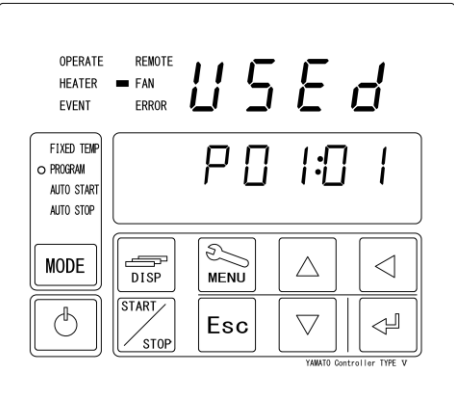









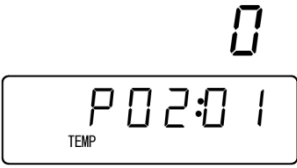

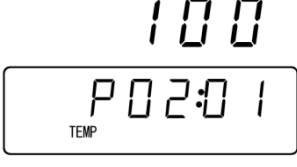

















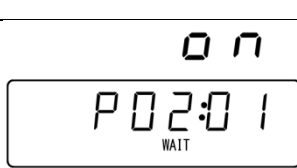



4. Operating procedure

Programming Method

NO	Indication	Operating procedure
I		
II		<p>[PROG] flashes.</p> 
III		<p>○ The PROGRAM lamp flashes.</p> <p>[USED] means that the program has already been registered.</p> <p> [1] of P01:01 flashes.</p> <p> Makes [1] of P01:01 flash.</p> <p> Input as [P02:01].</p>
1-1	<p>Inputting [P02: * *] of program pattern 02</p> <p>-----</p> 	<p>[2] of P02:01 flashes and the Top screen shows [-----] which means any programs are not registered.</p>

















4. Operating procedure

Programming Method

<p>1-2</p>		<p>Input pattern 02, STEP 01.</p>  TEMP flashes.
<p>1-3</p>		<p>Input 100°C.</p>  [000] flashes →    → 
<p>1-4</p>		<p>00 hour 00 minute</p>  MENU TIME flashes →  → 
<p>1-5</p>		<p>Repeat:0 (No repeat destination)</p>  MENU REP flashes. →  → 
<p>1-6</p>		<p>Number of repetition:0 (No repetitions)</p>  MENU REP flashes. →  → 
<p>1-7</p>		<p>Wait function ON setting (Set time counts down when the indicated temperature is -3°C to the set temperature and within +6°C.)</p>  MENU WAIT flashes. →  →   →  
<p>1-8</p>		<p>Variable wind speed ; 10 (maximum wind speed)</p>  MENU FAN flashes.. →  →    







4. Operating procedure

Programming Method

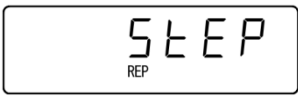
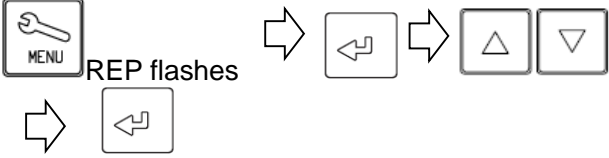
1-9	If a setup of STEP1 is completed	Press the  key longer.
2-1	<p style="text-align: center;">- - - -</p> <div style="border: 1px solid black; padding: 5px; width: fit-content; margin: auto;">P02:02</div>	Input pattern 02, STEP 02 
STEP02 } STEP03 } STEP04 } STEP05 } STEP06	Input parameters from STEP #2 to #6 in accordance with setting conditions with same process of inputting parameters on STEP #1 .	※ Press  key while registering program. Show [REST. P] on Bottom Screen. And show the rest of available steps on Top Screen.
7-1	<p style="text-align: center;">- - - -</p> <div style="border: 1px solid black; padding: 5px; width: fit-content; margin: auto;">P02:07</div>	Input pattern 02, STEP 07  TEMP flashes.
7-2	<p style="text-align: center;">150</p> <div style="border: 1px solid black; padding: 5px; width: fit-content; margin: auto;"> TEMP P02:07 </div>	Input 150°C.       
7-3	<p style="text-align: center;">00:00</p> <div style="border: 1px solid black; padding: 5px; width: fit-content; margin: auto;"> TIME P02:07 </div>	Input 00 hour 00 minute.  TIME flashes    

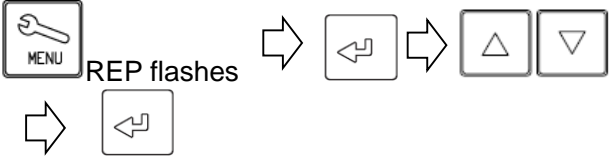

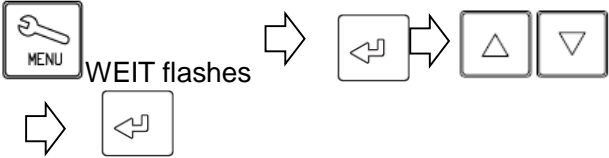
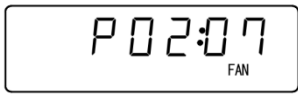
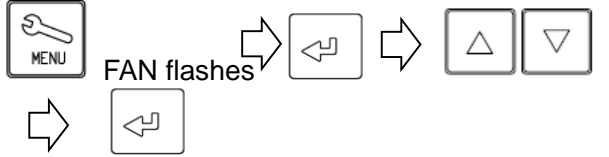
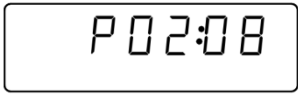



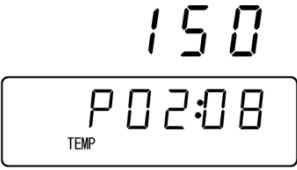

4. Operating procedure

Programming Method

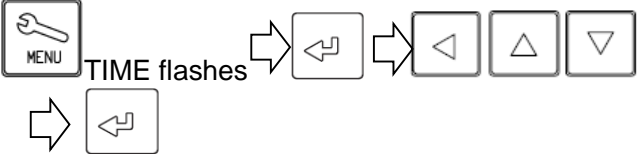
<p>7-4</p>	<p style="text-align: right;">4</p> 	<p>Input repeat destination (Repeat dstn : 4)</p>  <p>REP flashes</p>
<p>7-5</p>	<p style="text-align: right;">5</p> 	<p>Input the number of repetitions (Number of repetitions : 5) ※ Number of repetitions may be set between 1 and 99 or [INF], limitless.</p>  <p>REP flashes</p>
<p>7-6</p>	<p style="text-align: right;">ON</p> 	<p>Set the wait function to ON. (Set time counts down when the indicated temperature is -3°C to the set temperature and within +6°C.)</p>  <p>WEIT flashes</p>
<p>7-7</p>	<p style="text-align: right;">10</p> 	<p>Variable wind speed ; 10 (maximum wind speed)</p>  <p>FAN flashes</p>
<p>8-1</p>	<p style="text-align: center;">- - - -</p> 	<p>Input pattern 02. STEP 08</p> <p>Press the  key longer.</p> <p> TEMP flashes.</p>

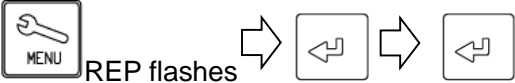
4. Operating procedure

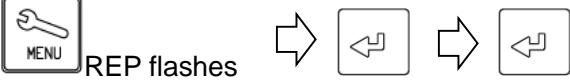
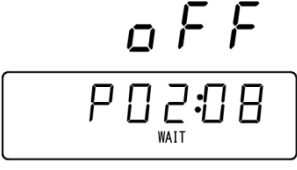
Programming Method

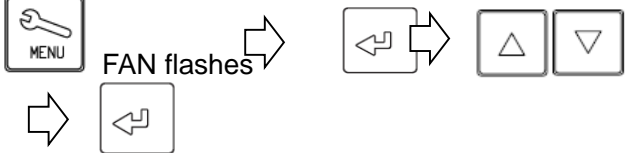
8-2		<p>Input 150°C.</p> 
8-3		<p>Input 00 hour 30 minutes. ※ Inputting [INF] for the final step makes its time limitless.</p> 
8-4		<p>Input repeat [0] (No repeat dstn)</p> 
8-5		<p>Input a repeat number of [0] (No repetitions)</p> 
8-6		<p>Set the wait function to OFF.</p> 
8-7		<p>Variable wind speed ; 3 (low wind speed)</p> 

4. Operating procedure



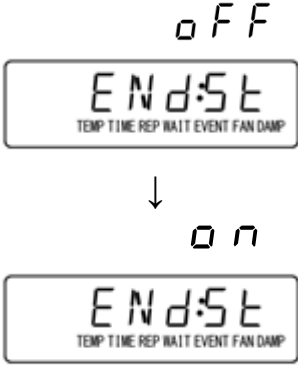
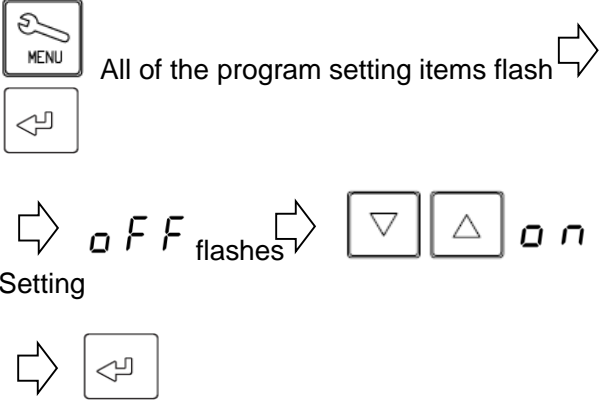
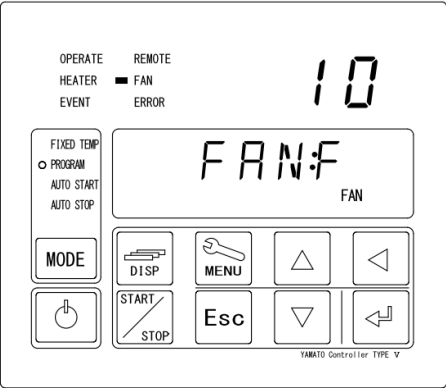
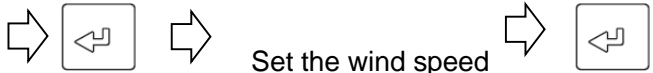





Programming Method

<p>8-8</p>		 <p>All of the program setting items flash</p> <p>Setting</p> <p>※ Be sure to set the END step ON for the final step of a program pattern. Any operation programs without an END step ON will not be recognized as a complete program.</p>
<p>8-9</p>		<p>【Setting the wind speed】</p> <p>FAN:F FAN Indicated</p>  <p>Set the wind speed</p> <p>※ The set value of “FAN:F” in this setting screen does not apply to the FAN rotations during constant-value operation.</p>

※ Duplicate and use the programming sheet at the end of this book.









4. Operating procedure

How to copy or delete programs

<p>1-1</p>		<p>※ Copying a program</p> <p>Use the  key to flash [COPYP] on the Bottom screen and press the  key.</p>
<p>1-2</p>		<p>When [01] of PGM:01 flashes, input the pattern number to copy from with the   keys and then determine using the  key.</p>
<p>1-3</p>		<p>[DESt] flashes on the Top screen shows while pattern numbers not used and [**] of PGM:** flash on the Bottom screen and input a pattern number [**] of the copy destination with the   keys and determine using the  key.</p>
<p>1-4</p>		<p>The Top screen shows [\square h] and the Bottom screen shows the pattern number of the copy source- copy destination number [01-02] then the screen will move to the program copy screen.</p>

4. Operating procedure

How to copy or delete programs

<p>2-1</p>		<p>※ Deleting a program You cannot delete a program during operation. Carry out deletion while the stand-by screen is displayed.</p> <p>Use the  key to flash [DELP] on the Bottom screen and then press the  key.</p>
<p>2-2</p>		<p>When [01] of PGM:01 flashes, select a pattern number to delete with the   keys or select [AL](all delete) with the  key and then press the  key longer.</p>
<p>2-3</p>		<p>When [DEL] flashes, determine using the  key.</p>
<p>2-4</p>		<p>The Top screen shows [] and the Bottom screen shows the pattern number of the copy source- copy destination number [PGM:02] then the screen will move to the program delete screen.</p>

4. Operating procedure

About the wait function

When the wait function is set to [ON], the mode will remain “waiting” without counting down the time until temperature in the chamber (indication) will be within the wait deviation range between -3°C and $+6^{\circ}\text{C}$ to the set temperature. When you set the set time to 0 minute, the unit will operate from the “Start temperature” to the “Set temperature” at full power.

When you have set time longer than the specified performance, the unit will control heating and cooling so that the set temperature will be attained at the set time.

Even when the indicated temperature drops while temperature is stable due to opening of the door, the mode will remain “waiting” without counting down the time if the wait width upper or lower limit is exceeded.

When you set the wait function to [OFF], the unit will proceed to the next step at the set time irrespective whether the temperature is within the wait width deviation between the set temperature and the indicated temperature.

When the set time is set to a short time exceeding the heating and cooling capacity, the unit will proceed to the next step before the set temperature is attained and you need to make sure that the wait function is set at [ON] when you are going to operate at the full power.

※ Example of estimated heating/cooling at indicated setting of wait [All ON] and [ALL OFF] in the program in the table below.

Step	1	2	3	4	5	6	7	8	9	10
Set temp($^{\circ}\text{C}$)	100	100	50	50	100	100	50	50	75	75
Set time	0 min	30 ,on	0 min	30 min	0 min	5 min	0min	5 min	2 hr	30 min
	Heating and cooling time of steps (1), (3), (5) and (7) are at the full power setting.									
	Heating time of the step (9) has been set longer than the specification.									

【Example of estimated process at “Full ON” setting for the wait function】

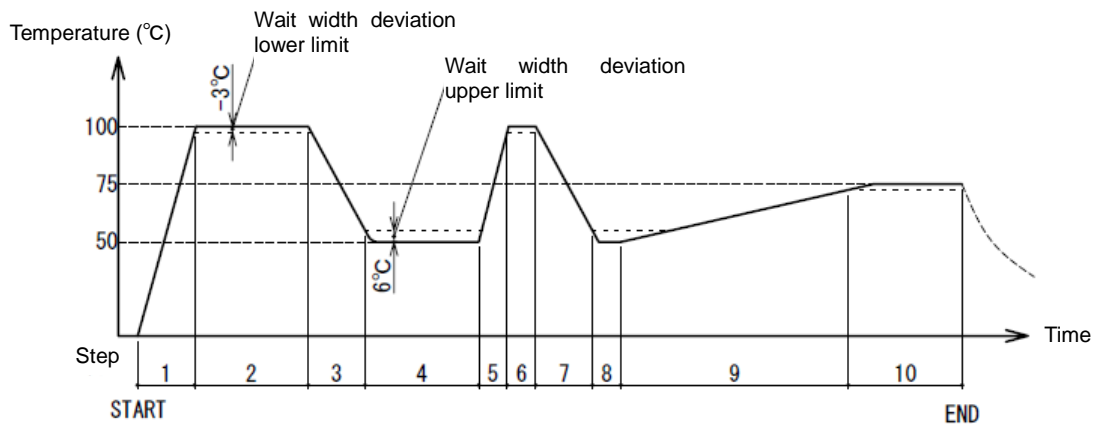



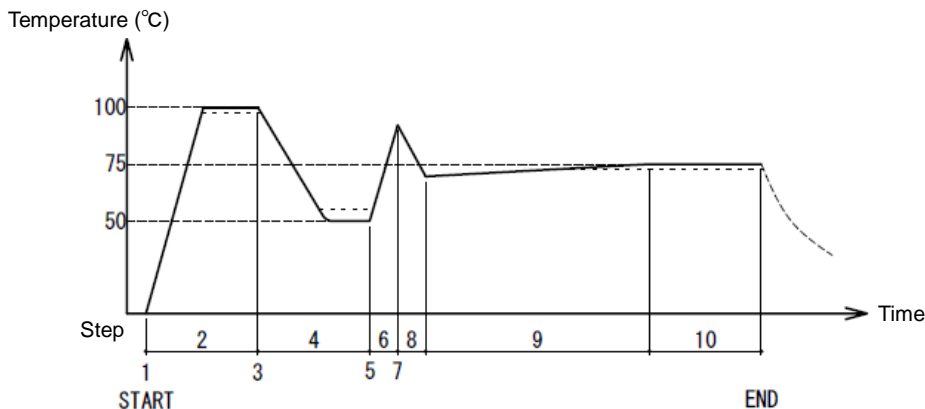







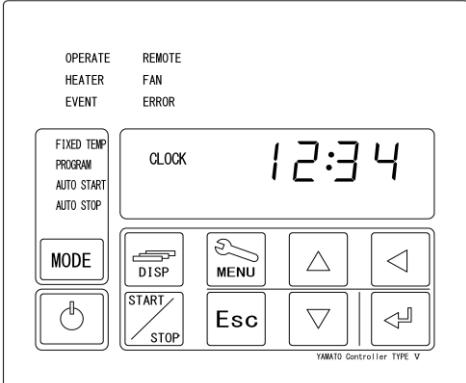

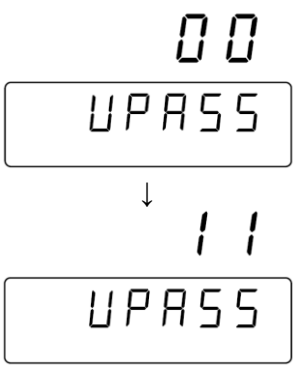





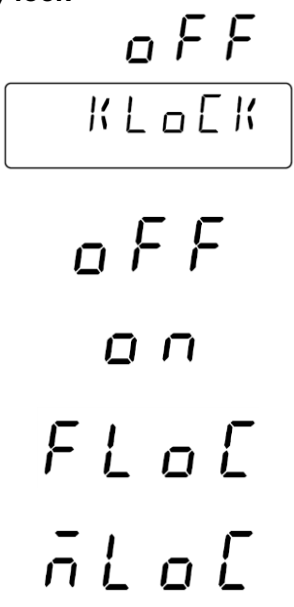

【Example of estimated process at “Full OFF” setting for the wait function】



4. Operating procedure

Setting key lock mode

※ Set a type of key lock.

<p>1 Turn the controller power off</p> 	<p>Turn the ELB on the right side of the main unit [ON()]. The Bottom screen will show the current time.</p> <p>While the unit is being operated, press the  key longer to turn the controller power off.</p>
<p>2 Enter password</p> 	<ol style="list-style-type: none"> Press and hold  key. Show [UPASS] on Bottom Screen and [00] flashing on Top Screen. Press ,  and  keys to enter password "11" on Top Screen and press  key (The password is fixed to "11").
<p>3 Set key lock</p> 	<ol style="list-style-type: none"> The Bottom screen shows [KLOCK] while the Top screen shows [OFF]. [OFF] is the factory setting. Use the , , ,  keys to select a type of key lock and then determine using the  key. <p>OFF : Key lock function disabled (Factory setting)</p> <p>ON : Any keys other than the ,  and the  keys are disabled.</p> <p>FLOC : Only the  key is disabled.</p> <p>mLOC : Only the  key is disabled.</p> <ol style="list-style-type: none"> Pressing the  key longer will return to the time display screen.

4. Operating procedure

Calibration offset

Calibration Offset Function offset the difference between read temperature by this Controller and actual measured temperature of Chamber. This Function enable parallel compensation in minus or plus direction over the whole Controller Temperature Setting Range of this Equipment.

Example

When the measured Chamber temperature is lower than read temperature by 2°C:

The read temperature can be calibrated by inputting "Calibration Offset value -2.0" for 2°C compensation against actual Chamber temperature.

If read temperature is 200°C for example, its temperature will shift to 198°C after offset calibration.

※ **This -2°C compensation is applied over the whole controller Temperature Setting Range (0 ~ 260°C). Note that offset value might be changed depending on sample setting arrangement and/or Target Temperature.**

1 Turning the controller power off

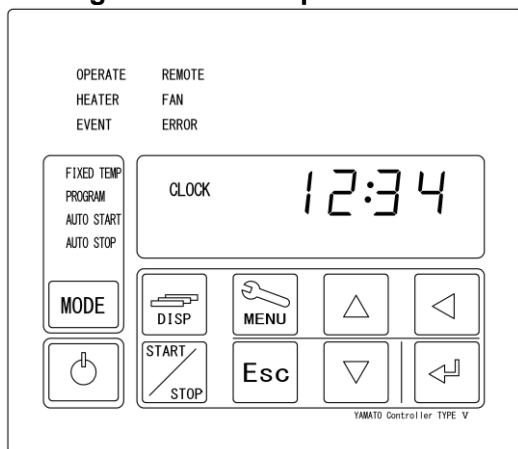

Turn the ELB on the right side of the main unit [ON(|)]. The Bottom screen will show the current time.



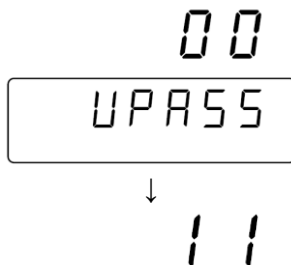

While the unit is being operated, press the  key longer to turn the controller power off.

2 Enter password.



① Press and hold  key.

Show [UPASS] on Bottom Screen and [00] flashing on Top Screen.

② Press   and  keys to enter password "11" on Top Screen and press  key (The password is fixed to "11").







4. Operating procedure

Calibration offset

3 Set Calibration Offset value.

0.0
CAL:0.5

00.0
↓
-2.0

- ① Press  key to display [CAL:0S] on Bottom Screen then press  key.
- ② Input offset value by   and  keys and then press  key. You can enter an offset amount up to $\pm 15.0^{\circ}\text{C}$

Example

Read temperature : 200°C and actual measured temperature : 198°C

⇒ Offset input value: -2.0°C











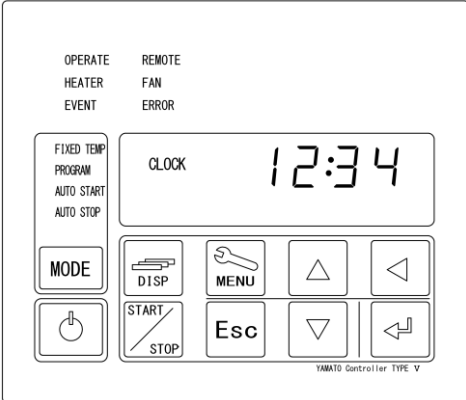

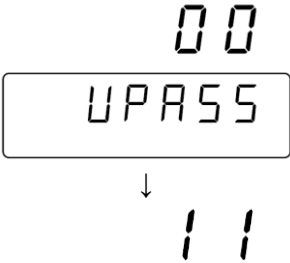

※ Although you can input values up to the first decimal place, the temperature indications and measured temperatures will be rounded before indication.

- ③ Pressing the  key longer will return to the time display screen.

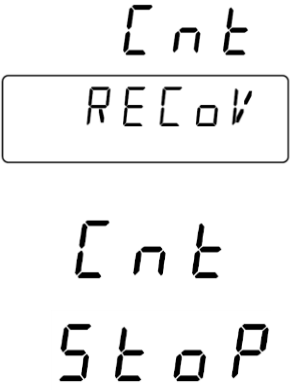
4. Operating procedure

Setting the recovery mode

※ Describe the recovering operation at power failure.

<p>1</p>	<p>Turning the controller power off</p>  <p>The diagram shows a control panel with a digital display showing '12:34' and 'CLOCK'. Above the display are indicators for OPERATE, REMOTE, HEATER, FAN, EVENT, and ERROR. Below the display are several buttons: MODE, DISP, MENU, and directional arrows. At the bottom are START/STOP, Esc, and another set of directional arrows. The text 'YAMATO Controller TYPE V' is visible at the bottom of the panel.</p>	<p>Turn the ELB on the right side of the main unit [ON()]. The Bottom screen will show the current time. While the unit is being operated, press the  key longer to turn the controller power off.</p>
<p>2</p>	<p>Enter password.</p>  <p>The diagram shows a digital display. The top part shows '00' and 'UPASS' in a box. An arrow points down to '11'.</p>	<p>③ Press and hold  key. Show [UPASS] on Bottom Screen and [00] flashing on Top Screen.</p> <p>④ Press   and  keys to enter password "11" on Top Screen and press  key (The password is fixed to "11").</p>
<p>3</p>	<p>Setting recovery from a power outage</p>  <p>The diagram shows a digital display. The top part shows 'Cnt' and 'RECOV' in a box. Below it, 'Cnt' and 'STOP' are shown.</p>	<p>① Press  key to display [RECOV] on Bottom Screen and then press  key.</p> <p>② Press   key to select recovery type at power failure and press  key.</p> <p>CNT : The operation will resume right at power failure after power recovery. (set at factory)</p> <p>STOP : The operation will terminate as Idle State after power recovery.</p> <p>③ Pressing the  key longer will return to the time display screen.</p>

4. Operating procedure

Resetting integrated CO2 volume and CO2 emission factor

※ Explain how to set conversion factor for CO2 emission and how to reset the integrated CO2 volume on Top Screen.

1 Turning the controller power off

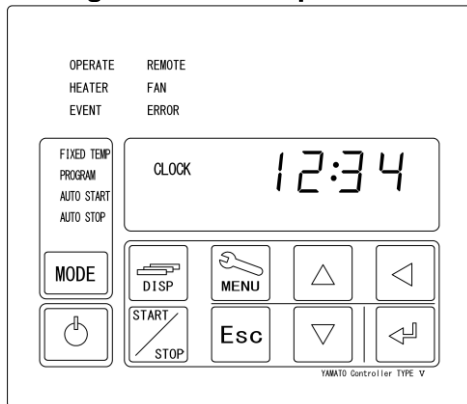

Turn the ELB on the right side of the main unit [ON(|)]. The Bottom screen will show the current time.



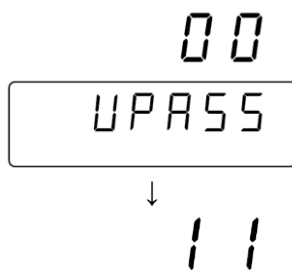

While the unit is being operated, press the  key longer to turn the controller power off.

2 Enter password.





① Press and hold  key.

Show [UPASS] on Bottom Screen and [00] flashing on Top Screen.

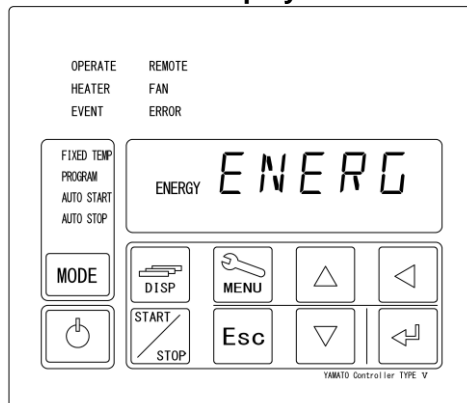

② Press   and  keys to enter password "11" on Top Screen and press  key (The password is fixed to "11").

3 Reset monitor display.



① Pressing the  key will make the monitor function indication ENERGY and [ENERG] flash on the Bottom screen.

② Pressing the  key will show items to reset integrated [POWRT] power consumption.

③ Press  key to select monitoring item on Bottom Screen and then press  key.

POWRT : Integrated power consumption

Pressing the  key will result in:

OFF (lit) → RUN (flash)

Press  key to reset Integrated Power Consumption.

Press  key to return to [PoW:Rt].

4. Operating procedure

Resetting integrated CO2 volume and CO2 emission factor

4

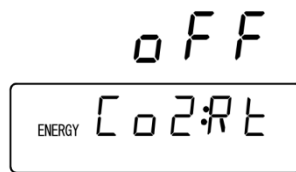
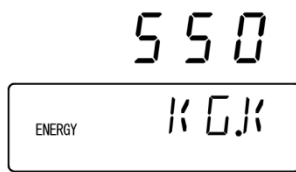

KG. K : (CO2) discharge coefficient

Quoted from the substitutive values, factory setting of **550** (0.000550t-CO2/kWh) , the Environmental Ministry Press Release on 6 November 20013.

Confirm the discharge coefficient of different utility companies with each company.

Pressing the  key will result in:
550 (lit) → **0550** (flash)

Press the    keys to change a discharge coefficient.

 key is used to determine

 key is used to return

CO2:RT : Integrated CO2 Emission

Press  key, and then change from OFF (illuminate) to →RUN (flash) on Top Screen.

 key is used to reset Integrated CO2 Emission.

 key is used to return

④ Pressing the  key longer will return to the time display screen.

4. Operating procedure

Backup data saving / reading out / resetting

※ Back up, read out and reset controller for various setting information.

1 Turning the controller power off

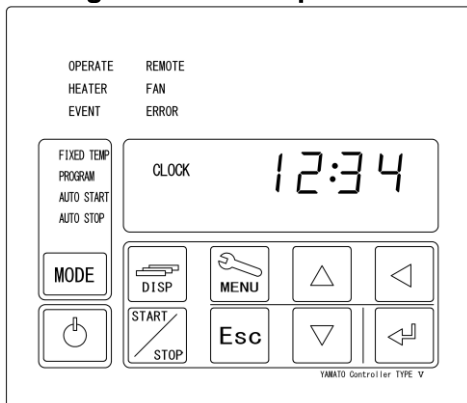

Turn the ELB on the right side of the main unit [ON(|)]. The Bottom screen will show the current time.

While the unit is being operated, press the key longer to turn the controller power off.

2 Enter password.

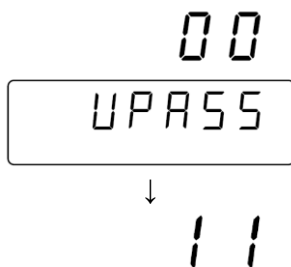

③ Press and hold key.

Show [UPASS] on Bottom Screen and [00] flashing on Top Screen.

④ Press and keys to enter password "11" on Top Screen and press key (The password is fixed to "11").

3 Save and read out and/or reset setting information.

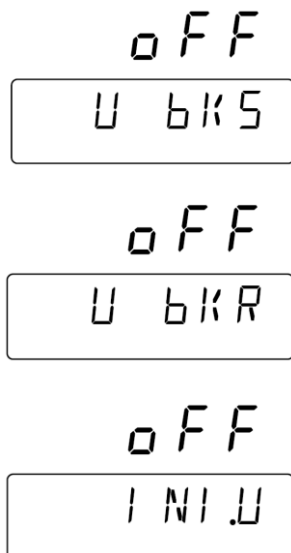

① Press key few times and show following items on Bottom Screen, respectively:

U BKS : Back various setting information up.

key「RUN」(flash)→ key「OFF」(illuminate)

U BKR : Read backup setting information out.

key「RUN」(flash)→ key「OFF」(illuminate)

INI. U : Initialize various setting information.

key「RUN」(flash)→ key「OFF」(illuminate)

※ Various setting information will be included registered programs, temperature offset value and other data such as key lock mode, calibration offset, recovery mode and so forth.

② Pressing the key longer will return to the time display screen.

4. Operating procedure

Monitoring data

※Check Integrated Power Consumption, integrated Operating hours and so forth by this “Monitor Item Display” function of this Equipment.
Can not modify any setting information shown on Top Screen.

1 View integrated value on Top Screen

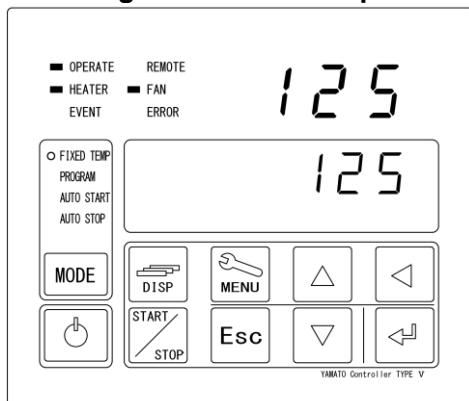

※Monitor Items can be checked at Controller POWER key ON or during operation state.

Press and Hold  key.

Monitor Items display screen activate and current Power Consumption appear on Top Screen.

Use the  key shows the integrated power consumption (MW) (kW), CO2 discharge amount (t) (kg) heater operation amount (%), integrated live time (Unit: 10000 hours) (Unit: 1000 hours), integrated operation time (Unit: 10000 hours) (Unit: 1000 hours).

Monitor Items display screen is ended, and Idle Screen or Standby Screen is displayed finally.

0.0

ENERGY KW

KW

Current Power Consumption is calculated from instantaneous power to power at one hour.

Power consumption may be indicated as [0.0] and [3.6] alternately while temperature is stable. Power consumption is indicated as [0.0] during standby.

123

ENERGY t:t:MW

TOT:MW

Integrated power consumption (MWh). This is indicated in a three-digit integer number.

456

ENERGY t:t:KW

TOT:KW

Integrated power consumption (kWh). This is indicated in a three-digit integer number.

【 Sample indication 】 Integrated power consumption:123,456kWh

456

ENERGY Co2:_t

CO2:_T CO2 discharge amount (t). This is indicated in a three-digit integer number.

CO2 discharge amount is calculated by multiplying the power consumption by a discharge coefficient. Confirm the discharge coefficient of different utility companies with each company.

The initial value input is quoted from the substitutive values, factory setting of 0.550(k-CO2/kWh), the Environmental Ministry Press Release on 6 November 20013. For updates of the coefficients, see the section, Setting and resetting the monitor indication, item [3].

789

ENERGY Co2:kG

CO2:KG CO2 discharge amount (kg). This is indicated in a three-digit integer number.

【 Sample indication 】 CO2 discharge amount:456,789kg

<p style="text-align: center;">45.6</p> <div style="border: 1px solid black; padding: 5px; margin: 5px auto; width: fit-content;">ENERGY PID:MV</div> <p style="text-align: center;">5</p> <div style="border: 1px solid black; padding: 5px; margin: 5px auto; width: fit-content;">ENERGY POW:TM</div> <p style="text-align: center;">67</p> <div style="border: 1px solid black; padding: 5px; margin: 5px auto; width: fit-content;">ENERGY POW:TM</div> <p style="text-align: center;">1</p> <div style="border: 1px solid black; padding: 5px; margin: 5px auto; width: fit-content;">ENERGY RUN:TM</div> <p style="text-align: center;">23</p> <div style="border: 1px solid black; padding: 5px; margin: 5px auto; width: fit-content;">ENERGY RUN:TM</div>	<p>PID:MV Heater Operation Output Heater Operation Output is the parameter to control output power ratio in percent of heater rated capacity. Heater output will be controlled by PID operation value between 100 to 0% till reaching to Target Temperature.</p> <p>【Sample indication】 Present heater operation amount: 45.6%</p> <p>POW:TM Integrated live time (hours). Only the ten thousand digit will be indicated.</p> <p>Integrated live time shall be the accumulated time elapsed from turning the ELB ON() to OFF OFF(○).</p> <p>POW:TM Integrated live time (hours). Up to the thousand place is displayed.</p> <p>【Sample indication】 Integrated Power ON Hours ; 50,067 hours Adding capability will up to 65,535 hours.</p> <p>PUN:TM Integrated operation time (hours). Only the ten thousand digit will be indicated.</p> <p>Integrated Operation Run Hours mean to add operation hours from start to end.</p> <p>PUN:TM Integrated operation time (hours). Up to the thousand place is displayed.</p> <p>【Sample indication】 Integrated live time: 10,023 hours Up to 65535 hours can be cumulated.</p> <p>Use the  key to the standby/operating screen.</p>
---	--

4. Operating procedure

Independent Overheat Prevention Device

This Equipment have redundant safety devices-1) Automatic Overheat Prevention (automatic reset) function on the Controller, and -2) Independent Overheat Prevention Device (IOPD) with independent power, circuit and sensor away from the Controller.

Main Relay of this Controller will be shut heater output power off when one of safety devices is activated at Chamber internal temperature beyond its setting temperature.

Those functions will avail at Earth Leakage Breaker(ELB) ON (|).

Set temperature on Independent Overheat Prevention Device(IOPD)

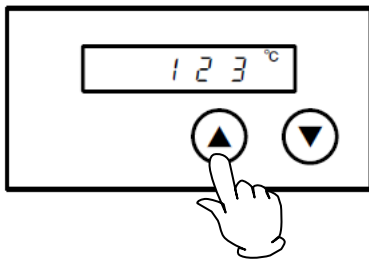

※Set temperature with ▼▲ keys on its panel.



May stop its operation by activating Independent Overheat Prevention Device(IOPD) when the difference between set temperature on IOPD and Target Temperature will be too close each other. Must set IOPD temperature at least 30°C higher than Target Temperature.

Note that the objective of this IOPD will not protect for samples but from overheating this Equipment.

Factory settings and setting temperature ranges are as shown below:

Model	Set temperature at shipment	Setting temperature range
DNF301	290°C	0°C~300°C
DNF401	290°C	0°C~300°C
DNF411	290°C	0°C~300°C
DNF601	290°C	0°C~300°C
DNF611	290°C	0°C~300°C

Control Chamber stable at required temperature first, and let IOPD setting temperature down by 1°C and then find out IOPD activating temperature, if IOPD will get to be activated at required temperature.

Must wait for 5(five) seconds for the next 1°C down of IOPD setting temperature, because its function will be operated to need some times.

Display ER07 on Top Screen on Control Panel, if this IOPD is activated.

When you have set an operation temperature you want for IOPD , recording of the set temperature takes several seconds and you need to wait for about five seconds before turning the ELB off.

5. Handling precautions

Warnings and Cautions

1. Never use any explosive or flammable substances.



Never process any explosive, flammable samples and also samples contained with those substances. It will cause fire/explosion. (See Chapter 13. List of dangerous materials on page 78.)

2. Take extreme care when using a resin container.



Be sure to check the withstand temperature before using a resin container. Using such a container under a temperature beyond its withstand temperature will melt resin and a fire or an explosion may result.

3. Turn the ELB off when an abnormality occurs.



Turn immediately off Earth Leakage Breaker (ELB) of this Equipment and disconnect Power Cord/Power Cable from receptacle or switch board of facilities, if smoke or strange smell is generated from it by any chance.
Contact with local dealer or Yamato sales office and/or Yamato Customer service Center and ask them to inspect it. If nothing is done to it, fire or electrical shock may result.
Never repair it by customer themselves to avoid any dangers.

4. Do not put any foreign objects in the unit.



Never insert any metal or easily flammable objects into the openings in the chamber (radiation port, cable port, etc.). A fire, an electric shock or burning may result.



If a foreign object has entered inside, immediately turn the ELB off and ask your dealer, one of our sales offices or the customer service center for inspection.
Leaving as it is will cause a fire or an electric shock.

5. Take extreme care for handling of samples after operation at a higher temperature.



Take care not to touch samples when taking them in or out since inside the chamber, internal wall of the door or samples are still hot for some time after operation at a higher temperature. Be sure to put on heat-resistance gloves and take extreme care for burning when handling samples.

6. Take extreme care when opening the door during operation at a higher temperature.



When you attempt to open the door during operation at a higher temperature, never touch the door since the internal chamber or the inside of the door are hot.
When the door is opened, the heater and the fan motor will stop for safety but note that the fan motor will keep rotating from inertial and hot air will be blown out.



Note that if a fire alarm is installed around the unit, it may go off erroneously.

7. Never attempt to touch hot surfaces.



Never touch the door, the cable port, suction port or around the exhaust port (optional) during or immediately after operation. They are hot and may cause burning.

5. Handling precautions

Warnings and Cautions

8. Do not climb on the Equipment.

- Do not climb on this Equipment. May cause personal injury and/or its failure by tipping it over and being damaged.

9. Do not place any stuff on the Equipment

- Do not place any stuff on this Equipment. May cause personal injury falling it off.
Do not close up any flammable materials such as paper around it.

10. Turn immediately off the Breaker of the Equipment at thundering.

- Turn immediately off the Breaker of the controller, when thundering and lightning start. If do not so, it may cause fire or electric shock by the thunderbolt.

11. Do not keep Door open after operation.

- Do not keep Door open to cool the sample down quickly, etc. right after operation. May deform Control Panel and cause failure of this Controller by heat wave from Chamber.

12. Do not process any corrosive samples.

- Do not process any samples containing corrosive chemicals even though Chamber is made of stainless steel which this steel may be corroded by strong chemical acid, etc.

13. Operate at the proper temperature

- Operating temperature range will be room temperature $15^{\circ}\text{C}\sim 260^{\circ}\text{C}$ (at forced wind) and room temperature $1+25^{\circ}\text{C}\sim 120^{\circ}\text{C}$ (at natural convection) .
Never operate this Equipment at temperature out of its range. Operating the unit outside the operating temperature range may cause a malfunction of the unit or an accident.

14. Take extreme care when placing samples.

- Do not set samples heavier than 15kg. Weight capacity of one shelf will be about 30kg
Spread samples evenly throughout on each shelf as many as possible.

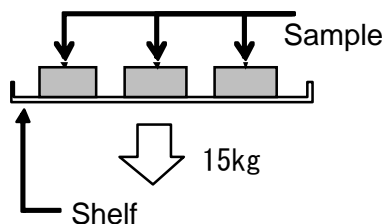

- Do not set excessive amount of samples on shelves. Chamber temperature may not be controlled correctly. Must keep following procedure to control Chamber temperature correctly; 1) install the supplied shelves, 2) keep space between samples as wide as possible. 3) require space opening more than 30% at each shelf.

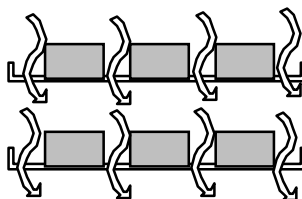

Require space opening more than 30% at each shelf.

5. Handling precautions

Warnings and Cautions

15. Never set samples on bottom of Chamber.



Never set samples on bottom of Chamber. If samples will be processed at setting on bottom of it, this Equipment may be not given as its full performance and become high temperature unlikely and also cause failure.

Set samples on attached shelves properly installed on their brackets.

Do not allow samples to contact directly to side walls of Chamber.

16. Drain the sample that contains large amount of water.



When processing any wet sample, drain it thoroughly before putting it into the oven. Wet sample may cause rusting, corrosion, dewing inside and outside the bath. In addition, excessive temperature rise caused by such sample may affect the electric system adversely, possibly causing leakage or failure of normal operation and finally resulting in fault.

17. Take care for processing of powder and small samples.



The unit employs Forced wind system to improve temperature distribution inside the chamber. When processing powder or small samples, make sure that the sample will not scatter. A fire or an electric shock may result if a flammable or a metal object enters the heater.

Operate in the natural convention manner when handling powder or small samples. When the forced wind system is employed, the circulation wind in the bath can be suppressed by setting the variable wind speed to low, but the temperature performance is outside the scope of guarantee. In this event, the customer is requested to confirm the temperature performance.



Heating may take some time when the amount of samples is large or when processing samples with a larger heat burden. Check the appropriate amount as necessary and set the sample. Also note that the temperature indication may be unstable when processing heat-generating samples (note that sample itself must be free of fear of explosion, inflammation or ignition).

18. Note that the sample temperature and the measured temperature are not always the same.



Be aware of temperature sensor which it is installed on the upper right depth of the Chamber and control Chamber temperature. Therefore, if the amount of sample is large or the equipment is in the middle of heating, sensor detected temperature may not agree with temperature of the samples. In particular, actual Chamber temperature will differ greatly from Read Temperature displayed on Controller, right after opening or closing of this Equipment Door.

When a gap occurs between the temperature in the bath and the measured temperature requiring adjustment, compensate temperature by referring to "P.46 Setting a calibration offset".

19. Check the following in terms of the recovery mode.



When operation stopped from a power failure and then power recovers, the unit will automatically resume operation.

See "P.48 Setting the recovery mode" for details.

20. Be sure to set a temperature of the Independent Overheat Prevention Device.



Must be set temperature of Independent Overheat Prevention Device (IOPD).

Note that temperature of this IOPD must be set to temperature over 30°C higher than Target Temperature.

Refer to Chapter 4. Operating Procedure – "Independent Overheat Prevention Device" for how to set and other cautions on page 54.

5. Handling precautions

Warnings and Cautions

21. Take care for the following in terms of the Gasket on Chamber.



Be aware of Gasket on Chamber that is made from silicon rubber and may vaporize benzoic acid, oil, etc. from volatile components of rubber used at their production during operation. Ask specific Gasket made from fluoro-rubber for samples that are not compatible with those chemicals.

Note that the rubber may be rusted or corroded by acids, alkaline, and halogenated solvent.

【Caution】

Show substances that they will erode silicon rubber (standard specification) and fluoro-rubber (special specification) for Chamber Gasket on Table 5.1.

Never process samples that will be contained these substances showing on its Table.

Please contact with Yamato Scientific Customer Service Center for applicability of substances

Table 5.1 - Typical substances eroding Gasket on Chamber

Material Classification	Silicon Rubber	Fluoro-rubber
Hydrocarbons	Butane, Isooctane, Benzene, Toluene, Xylene, Styrene, Diphenyl, Pinene, Kerosene	Propane
Halogen, Haloid Hydrocarbon	Methyl Chloride, Methylene Chloride, Chloroform, Carbon Tetrachloride, Trichloroethylene, Phlorobenzene, Monochloronaphthalene, R-11, R-12, R-21, R-22, R-113, R-114, Bromine	R-21, R-22
Ketone, Aldehyde	Methyl Ethyl Ketone, Diisopropyl Ketone, Diclhexanon, Acetophenone	Acetone, Methyl Ethyl Ketone, Methyl Isobutyl Ketone, Diisopropyl Ketone, Diclhexanon, Acetophenone
Ester	Methyl Acetate, Ethyl Acetate, Propyl Acetate, Butyl Acetate, Amyl Acetate, Methyl Acetoacetate, Butyl Acrylate, Ethyl Methacrylate	Methyl Acetate, Ethyl Acetate, Propyl Acetate, Isopropyl Acetate, Butyl Acetate, Amyl Acetate, Ethyl Acetoacetate, Ethyl Acrylate, Butyl Acrylate, Ethyl Methacrylate
Ether	Diethyl Ether, Dibutyl Ether, Ethylene Oxide, Dioxane, Epichlorohydrin, Tetrahydrofuran	Diethyl Ether, Isopropyl Ether, Dibutyl Ether, Dibenzyl Ether, Ethylene Oxide, Dioxane, Epichlorohydrin, Furfural, Tetrahydrofuran
Alcohol	Amyl alcohol	
Multiple Alcohol Derivative		Cellosolve Acetate, Butyl Cellosolve, Triacetin

5. Handling precautions

Warnings and Cautions

Material Classification	Silicon Rubber	Fluoro-rubber
Fatty Acid, Phenol	Acetic Anhydride, Oleic Acid, Phenol Palmitate	Formic Acid, Acetic Anhydride, Hydroquinone
Nitrogen Chemical Compounds	Nitromethane, Nitroethane, Nitropropane	Nitromethane, Nitroethane, Nitropropane, Ethylenediamine, Dimethylaniline, Ethanol amine, Hydrazine, Triethanol Amine, Dimethyl Formamide, Pyridine, Piperidine
Sulfur and phosphorus compounds	Hydrosulfuric	Hydrosulfuric, Tributyl Phosphate
Other Chemical Compounds	Nickel Acetate, Lead Acetate, Zinc Acetate, Tetraethyl Lead, Vegetable Oil, Silicon Oil	Calcium Acetate, Nickel Acetate, Lead Acetate, Zinc Acetate
Inorganic Solvent	Hydrochloric Acid, Nitric Acid, Sulfuric Acid, Hydrobromic Acid, Phosphoric Acid, Hypochlorous Acid, Chromic Acid, Perchloric Acid, Sodium Hydrate	Sodium Hydrate, Aqueous Ammonia

22. Never fail to perform periodic inspection.



Check regularly Earth Leakage Breaker (ELB) and Independent Overheat Prevention Device (IOPD) which they are key part/Device for the safety of this Equipment. Refer to Chapter 6. Maintenance Method on page 61.

23. Pay attention to the following when operating the product with the exhaust damper fully opened.



With the exhaust damper fully opened, the set temperature cannot be reached. Note also that the set temperature may not be reached in cases other than the damper fully opened. The customer is requested to check this in line with the variable speed before operation.

24. Take care for possible degradation of performance when using the cable port.



When a measurement sensor or a probe is inserted into the cable port close the cable port cover as much as possible and completely seal to any gaps with heat-resistant packing or sealant. If seal is insufficient, the temperature characteristic, cleanliness or other performance will degrade. Use an optional silicon plug (with one hole) as necessary. See "P.70 List of optional settings".

25. Smoke (odor) may generate when you operate the unit for the first time.



When you operate the unit for the first time, the bonding material of the heat insulation material may burn and generate odor, which, however, does not indicate a malfunction of the unit. Odor will not generate as you continue to use the unit for some time.

5. Handling precautions

Warnings and Cautions

26. Take extreme care during operation at a higher temperature



When you attempt to open the door during operation at a higher temperature, never touch the door since the internal chamber or the inside of the door are hot. Note that if a fire alarm is installed around the unit, it may go off erroneously.

27. Take extreme care after operation at a higher temperature.



Take care not to touch samples when taking them in or out since inside the chamber, internal wall of the door or samples are still hot for some time after operation at a higher temperature. Be sure to put on heat-resistance gloves and take extreme care for burning when handling samples.

28. Never use thinner or alcohol to remove soil off the unit.



Never apply any kinds of thinner and/or alcohol to wipe dirt off this Equipment. May come paint off, and may change its color or deform its shape, Otherwise. Note to turn Earth Leakage Breaker (ELB), off on the right side wall of this Equipment first, then maintain it.

29. About the fan motor operation



The fan motor keeps operating when the ELB is [ON(|)], the  key is on, and the door is closed. (The case with the fan set to 0 is excluded.)

Use the  key to turn the fan motor off to stop it.

30. About the ceiling of the main unit



Avoid placing any objects on the ceiling except for stacking using the optional stacking clamps.◦

31. Be sure to read the operating instructions.



Be sure to read the operating instructions before using the unit.

6. Maintenance method

Daily inspection/maintenance



Warning

- Be sure to turn off Earth Leakage Breaker(ELB) of this Equipment before daily inspection and maintenance
- Inspect and maintenance this Equipment at ambient temperature on its Chamber.
- **Never disassemble this Equipment.**



Caution

- Wipe dirt off with wrung tightly soft cloth.
- Never clean this Equipment with benzene, thinner or scouring powder, or rub with a scrubbing brush.
May cause deformation, degradation and/or discoloration.



Inspect monthly.

- **Inspect the ON and OFF functions of Earth Leakage Breaker(ELB).**
 - Prepare this Equipment for the inspection and connect Power Cord/Cable to receptacle or Switch Board of facilities.
 - Check ELB “OFF”, then turn ELB “ON (|)”.
 - Press test button on ELB with ball-point pen etc. If ELB is shut down, ELB will be functional.
- **Check operation of Independent Overheat Prevention Device(IOPD).**
 - Be operating this Equipment at appropriate Target Temperature on Fixed Temperature Operation Mode.
 - Set this IOPD working temperature down to approximately 10°C lower than Read Temperature.
 - Activate this IOPD and will be shut power off heater circuit in few seconds, and display “Er07” on Top Screen, display warning sign “Overheat” on Bottom Screen, illuminate ERROR Lamp on Control Panel, and buzz on the same time.
 - * Must check ELB and IOPD mentioned above prior to operate this Equipment for continuous long hours or unmanned operation during night time before starting operation.

- ◆ Contact immediately with local dealer, Yamato sales office, or Yamato Customer Service Center for any questions.

7. Long storage and scrap

When not using the Equipment for a long time / when scrapping

 Warning	 Caution
Do not operate this Equipment for the time being. <ul style="list-style-type: none"> • Turn Earth Leakage Breaker(ELB) off and disconnect Power Cord/Cable from receptacle /switch board of facilities. 	Scrap this Equipment. <ul style="list-style-type: none"> * Do not leave this Equipment alone where children may play and get at it. * Before discarding the equipment, be sure to remove the hinge and the door lock assembly so that you cannot close the door hermetically.

Matters to consider when scrapping the Equipment

Pay attention always to the preservation of the global environment.

We, as Yamato Scientific Co., Ltd. highly recommend taking this Equipment apart as far as possible for separation or recycling to contribute to the preservation of the global environment according to the specified garbage collection method stipulated by each local government.

List major components and their materials for this Equipment as follows:

Names of major parts	Material
Major components of the Equipment	
External Structure	Chrome free electrogalvanized carbon steel sheet coated w/Chemical-proof baking finish
Chamber	Stainless steel plate
Heat Insulator	Glass wool
Door packing	Silicon rubber
Major components of electrical parts	
Switch and Relay	Composite of resin, copper and other materials
Operation Panel	Polycarbonate resin
Printed Circuit Boards	Composite of fiber glass and other materials
Heater	Stainless steel pipe
Power Cord/Cable	Composite of synthesized rubber coating, copper, nickel and other compound materials
Wires	Composite of fiber glass, fire-retardant vinyl, copper, nickel and other materials
Stickers	Resin materials
Sensor (K thermo-couple)	Stainless steel and others

8. When a trouble occurs

Message error table

Show the error codes on Table 8.1 below.

Buzz and stop its operation at occurring errors on this Equipment.

Pressing any key (except for the  key) will stop the buzzer sound. When three minutes have passed as it is, the buzzer starts to sound again.

The Top screen shows an error code and the Bottom screen shows the error name. Note the error code, immediately turn power off and stop operating the unit.

Table 8.1 Table of Error Code

Error Display	Error Code Name	Causes and their solutions
ER01 SENS	Sensor Failure	<ul style="list-style-type: none"> ● Fail in temperature sensor. ● Open circuit on temperature sensor line. ● Detect temperature out of its designed range. Contact the general customer service center.
ER02 TRIAC	TRIAC short circuit error	<ul style="list-style-type: none"> ● Short on TRIAC circuit. ● Fail on Current Transformation (CT) sensor. Contact the general customer service center.
ER03 HEAT	Heater Line Disconnection	<ul style="list-style-type: none"> ● Heater Line Disconnection ● Fail on Current Transformation (CT) sensor. ● The source voltage has dropped. Contact the general customer service center.
ER04 FAN	Malfunction of the fan motor	<ul style="list-style-type: none"> ● Malfunction of the fan motor ● The rotation of the fan has decreased or the fan has stopped. Contact the general customer service center.
ER07 OHEAT	Independent Overheat Prevention Device(IOPD) activated	<ul style="list-style-type: none"> ● Activate Independent Overheat Prevention Device (IOPD). Turn ELB on again and check both Chamber temperature and setting Temperature of IOPD. Contact the general customer service center, if this Equipment is not energized at ELB on.
ER10 RELAY	Main Relay Contact melted	Check at turning ELB on again: <ul style="list-style-type: none"> ● Melt down the contact point of Main Relay. ● Fail on Current Transformation (CT) sensor(s). Contact the general customer service center.
ER14 RAM	RAM Failure Reduced capacity or end of use life of the backup battery	Check at turning ELB on again: <ul style="list-style-type: none"> ● RAM Failure : Reset power once. ● Reduced capacity or end of use life of the backup battery : Contact the general customer service center, if this error cannot be reset by ELB on. Must be replaced backup battery.

8. When a trouble occurs

Message error table

Error Display	Error Code Name	Causes and their solutions
ER15 EPROM	EEPROM Failure	<p>Check at turning ELB on again:</p> <ul style="list-style-type: none"> ● Change its data code on EEPROM. <p>Contact the general customer service center, if this error cannot be reset by ELB on.</p>
Temperature in the chamber DOOR	Door open	<p>Door is open.</p> <ul style="list-style-type: none"> ● This is not a malfunction. <p>When you open the door, [DOOR] flashes on the Bottom screen, the heater circuit is shut off for safety and the fan motor will stop. Closing the door will eliminate the [DOOR] indication, the heater circuit will recover automatically and the fan motor starts.</p> <p>Leaving the door open for about 2 minutes will activate the buzzer. Pressing any key (except for the  key) will stop buzzer sound.</p> <p>Leaving the door open will activate the buzzer after about 2 minutes.</p>

8. When a trouble occurs

Troubleshooting

Show troubleshooting guide on Table 8.2.

Refer to “Cause and their solutions” of Table 8.1 – Error Code on this Chapter “Message Error Table” on P. 63.

Table 8.2 - Troubleshooting Guide

Phenomena	Causes	Solutions
Do not display current time on Bottom Screen at Earth Leakage Breaker (ELB) ON.	<ul style="list-style-type: none"> ▪ Do not supply power. ▪ Fail ELB. ▪ Fail Controller. 	<ul style="list-style-type: none"> ▪ Check connection to power supply and apply power. ▪ Replace ELB. ▪ Replace Controller.
Do not display anything on both Top and Bottom Screen at Controller Power key pressed and held.	<ul style="list-style-type: none"> ▪ Fail supplied power. (Required Voltage $\pm 10\%$) ▪ Fail Controller. 	<ul style="list-style-type: none"> ▪ Connect to adequate power supply. ▪ Replace Controller.
The fan motor will not operate even if the power key of the controller is pressed.	<ul style="list-style-type: none"> • Fan motor malfunction • The door is open. • FAN is set at “0” 	<ul style="list-style-type: none"> • Replace the fan motor • Close the door. • Change the fan setting.
Do not rise Chamber temperature.	<ul style="list-style-type: none"> ▪ Activate IOPD and /or Self-diagnosis Function built-in on Controller, and shut heater circuit down (Error code displayed). 	<ul style="list-style-type: none"> ▪ Refer to “Cause and their solutions” of Table 8.1 – Error Code on page 63.
Display temperature unstable.	<ul style="list-style-type: none"> ▪ Fluctuate ambient temperature heavily. ▪ Fail supplied power. (Required Voltage $\pm 10\%$) ▪ Fail Controller. ▪ Fail Temperature Sensor ▪ Be affected by samples. 	<ul style="list-style-type: none"> ▪ Review its location. ▪ Connect to adequate power supply. ▪ Replace Controller. ▪ Replace Temperature Sensor. ▪ See “P.57 17. Take care for processing of powder and small samples”.

Contact with local dealer or Yamato Customer Service Center phenomena other than Table 8.2 above.

9. After sales service and warranty

Request to repair parts

Request to repair parts

When any abnormality occurs immediately stop operation, turn the controller power and the ELB off and contact your dealer, one of our sales offices or the customer service center.

Require the following information for repair.

- Model name of Yamato products
- Serial Number
- Date (year/month/date) of purchase
- Description of trouble in detail as possible

See Warranty Card or caution rating nameplate on this Equipment.
(See Chapter 3. Names and functions of each part "on page 11 for details.

Be sure to present the warranty card to Yamato service representative.

Keep Warranty Card with care.(attached separately)

- Keep Warranty Card with care.

Warranty Card would be given by local dealer or one of Yamato sales offices.

Date of purchase of this Equipment and other information should be filled in Warranty Card.

Please send Warranty Card to Yamato Customer Service Center (Yamato CSC) by facsimile described Fax number in the left top corner of it.

Then, keep its Card with good care.

- Repair this Equipment for free of charge according to the contents on Warranty Card.
Warranty period is 1(one) year from date of purchase.
- Consult with local dealer, one of Yamato sales office or Yamato CSC for any repair after warranty ended.
Charged repair service of this Equipment will be available on customer's request when it can be maintained functional by its repair.

Guarantee for maximum storage period of repair parts.

Guarantee that maximum storage period of repair parts will be 7(seven) years after end of their production, Variable wind-speed constant-temperature drying oven (2in1 oven).

Repair parts will be defined the parts to maintain this Equipment performance.

10. Specifications

Specifications

Product Name		Variable wind-speed constant-temperature drying oven (2in1 oven)				
Model Name		DNF301	DNF401	DNF411	DNF601 DNF611	
System		Forced wind circulation and natural convection				
Operating environment temperature range		5°C~35°C				
Power supply		Single phase AC115V	Single phase AC220V	Single phase AC115V	Single phase AC220V	
		Common to 50/60Hz, operating voltage range : ±10%				
Performance ※1	Temperature Control Range	0~270°C (wind speed 1~10) 0~130°C (wind speed 0)				
	Temperature control precision	Room temp +15°C~260°C (wind speed 1~10) Room temp +25°C~120°C(wind speed 0)				
	Temperature control accuracy (Forced wind)	±0.3°C (at 260°C)				
	Temperature control accuracy (Natural convection)	±0.5°C (at120°C)	±0.3°C(at 120°C)			
	Temperature fluctuation (Forced wind)	±0.5°C (at 260°C)				
	Temperature fluctuation (Natural convection)	±1.0°C (at120°C)	±0.8°C(at120°C)	±0.6°C (at120°C)		
	Temperature distribution accuracy (Forced wind)	±2.5°C(at260°C)				
	Temperature distribution accuracy (Natural convection)	±5°C (at120°C)	±3°C(at120°C)			
	Temperature gradient (Forced wind)	5°C (at260°C)	7°C (at260°C)	8°C (at260°C)		
	Temperature gradient (Natural convection)	15°C (at120°C)	13°C (at120°C)			
	Performance during circulating operation (damper fully closed) 、 maximum wind speed (FAN setting : 10) 、 room temperature: 23°C±5°C, rated voltage ±5%、 humidity 65%±20% and no load					
	Temperature rise time (Forced wind)	Approx. 70 min.	Approx. 105 min.	Approx. 100 min.		
	Temperature rise time (Natural convection)	Approx. 20 min.	Approx. 25 min.			
Performance value for a case of circulation operation (damper fully closed), maximum wind speed (Fan setting: 10), room temperature at 23°C, rated voltage, relative humidity at 65%±20%, and under no load						

10. Specifications

Specifications

Model		DNF301	DNF401	DNF411	DNF601	DNF611
Composition	Internal bath	Stainless steel plate				
	Insulation Material	Glass wool				
	Door	Single swing door				
	Heater	Stainless steel pipe heater				
	Heater capacity	0.8kW	0.6kW×2		0.83kW×2	
	Fan (motor)	Sorpcco fan/DC brushless motors				
	Variable wind speed function	Variable in 10 stages (600~1500rpm) + Wind speed "0"				
	Cable port	Inside dia. 33mm, one piece (right side)				
	Suction port	Inside dia. 33mm, one piece (right side)				
	Exhaust port	Outside dia.50mm, one piece (Back side)				
	Damper	Circulation – ventilation manually selectable : Suction/emission operation (260°C is not reached in total emission/fully opened state)				
コントローラ	Type	V-shaped controller				
	Temperature Control Method	PID Z control				
	Temperature setting method	Digital setting with ▲/▼ keys.				
	Temperature Display Method	Top Screen (Chamber) : Green 4-digit LED Digital Display (Resolution : 1°C) Bottom Screen : Orange 5-digit LED Digital Display (Resolution : 1°C)				
	Other displays	LED indicates temperature patterns for heating/stable/cooling				
	Timer	Settable between 1 minute and 99 hours 59 minutes: duration operation 24 hour setting: time operation				
	Operating function	Fixed temperature operation Program operation (Maximum 99 steps, up to 99 patterns, the repeat operation function) Duration/time select timer operation function (Fixed temperature operation auto start/auto stop/quick auto stop, program operation auto start)				
	Additional function	Variable wind speed function Power on and Operation Time Integrating Function(up to 65,535 hours); Calibration Offset; Monitor Display of Integrated Power Consumption, Total CO2 Emission, and Heater operating Output; Power Recovery Mode; Save and Access of Operator's Setting Information;				
	Heater Control	Triac with Zero-cross Control				
Sensor	K type Thermocouple double sensor					

10. Specifications

Specifications

Model		DNF301	DNF401	DNF411	DNF601	DNF611	
Safety Device	Controller	Self-diagnosis Functions (Temp. Sensor Failure Detection, TRIAC Short Circuit, Heater Line Disconnection, Main Relay Failure Detection, Automatic Overheat Prevention), Key Lock Function, Door switch, Independent overheat preventive device , ELB for Over-current, Fan Failure					
	Standard	Internal dimensions ※2 Width Depth Height	300mm 300mm 300mm	450mm 450mm 450mm		600mm 500mm 500mm	
External dimensions ※2 Width Depth Height		430mm 495mm 740mm	580mm 645mm 890mm		730mm 695mm 940mm		
Internal capacity		27ℓ	90ℓ		150ℓ		
Weight		Approx.50kg	Approx.75kg		Approx.90kg		
Number of tiers/shelf support pitch		6 tiers /30mm	11 tiers /30mm		13 tiers /30mm		
Withstand load of each shelf board		Approx. 15kg/ piece					
Power supply (50/60Hz)		Single phase AC100V		Single phase AC200V	Single phase AC100V	Single phase AC200V	
Power supply 50/60Hz)		8A	11.5A	7.5A	15.5A	10A	
Accessories	Shelf board and shelf support	Stainless steel punched plate (The bottom plate is held with screws)					
		2 pieces Shelf support ; 4					
	Instruction Manual	1 copy					
	Warranty card	1 copy					
Article	※ The length of power cord is about 2m outside the oven. ※1 Temperature control accuracy、 The temperature distribution accuracy subject to JTM K05 while temperature variation and gradient subject to JIS C60068 ※2 Protrusions are excluded.						

11. Accessory

List of accessories

Show the list of optional accessories for this Equipment on Tables 11.1 and 11.2.

Variable wind-speed constant-temperature drying oven (2in1 oven) DNF301/ DNF401/411/ DNF601/611 support a wide variety of optional parts.

※Note that some optional parts may not be installed after delivery.

Table 11.1 List of Options (installation possible after delivery)

Option	Product Code No.	Model Name	Applicable model	Remarks
Shelf board (Stainless steel punched plate) with shelf peg Withstand load: approx.15kg/container	212068	—	DNF301	Shelf board, made of stainless steel punched plate
	212246	—	DNF401/411	
	212266	—	DNF601/611	
Stand	211180	ON30	DNF301	Stand for DNF series
	211856	ON61	DNF401/411 DNF601/611	
	212348	OT42	DNF401/411	
	212349	OT62	DNF601/611	
Stacking clamp	281458	ODM44	For DNF301	Clamp to secure the upper and the lower DNF301/401/411/601/611 units by stacking them on each other.
	212806	ODN26	For DNF401/411	The clamp can be used for stacking with former series, DNF4** and DNF401/411 as well as DNF6** and DNF601/611.
	212807	ODN28	For DNF601/611	
Seath sensor (K thermocouple)	212946	ODT48	Common to all models	Temperature sensor for confirming the temperature in the chamber or of samples. This can be connected to an optional recorder.
Silicon plug (with one hole)	212947	ODT52	Common to all models	This silicon rubber plug for fixing and sealing gap of sensors inserted from the cable port. There is a ϕ 2mm hole at the center of it.
External Communication Adaptor Set	211880	OIN90	Common to all models	Connect this Equipment with PC through this adaptor for external communication. (Attach application software attached).
Recorder ※For detailed specifications, refer to the general catalog	281571	YHR150	Common to all types	6ch recorder for outdoor installation. When combined with the optional external communication, this recorder can display the set temperature, display temperature, and heater control input in three channels instead of six channels.
	281570	YHR250		
YHR connection cable	281474	ODM76	Common to all types	Cable to connect the above recorder with the main body, The optional external communication terminal is necessary for connection.

11. Accessory

List of accessories

Table 11.2 List of options (installation not possible after delivery)

Option	Product Code No.	Model Name	Applicable model	Remarks
Cable hole (Inside diameter: φ25mm)	281454	ODM36	Common to all types	For the installation location and quantity, contact us. Combination of φ25mm and φ50mm is possible/
Cable hole (Inside diameter:φ50mm)	281455	ODM38		
Exhaust duct	281459	ODM46	DNF301	Installed in the back. With duct cover. Height equivalent to the main body ceiling surface. With exhaust port flange (φ50mm) Hot air is exhausted upward.
	281460	ODM48	DNF401/411	
	281461	ODM50	DNF601/611	
External communication terminal (RS485)	281465	ODM58	DNF301	Monitor operation state of this Equipment and control it remotely.
	281464	ODM56	DNF401/411	
	281465	ODM58	DNF601/611	
Temperature output terminal (4-20mA)	—	—	—	This option, the temperature output terminal, cannot be used with this oven. Please use a separate option, that is, the recorder.
External Alarm Output Terminal	281466	ODM60	DNF401/411	Output alarm signal at occurring error on this Equipment. Display its particular error on Bottom Screen.
	281467	ODM62	DNF301 DNF601/611	
Timeup Output Terminal Operation Signal Output Terminal	281468	ODM64	DNF401/411	Output timeup signal “END” at the end of Automatic Stop Operation and/or Program Operation and displaying it on Bottom Screen.
	281469	ODM66	DNF301 DNF601/611	
Event Output Terminal Timeup Output Terminal	281470	ODM68	DNF401/411	Output operation signal at being operated of this Equipment.
	281471	ODM70	DNF301 DNF601/611	
Operation Signal Output Terminal	281472	ODM72	DNF401/411	Output ON-OFF signal set at each state such as standby, being operated, end of operation, and program steps.
	281473	ODM74	DNF301 DNF601/611	

These options may be installed or created after delivery or installation of the unit. Consult your dealer or one of our sales offices for optional parts.

12. Wiring diagram

DNF301 Wiring diagram

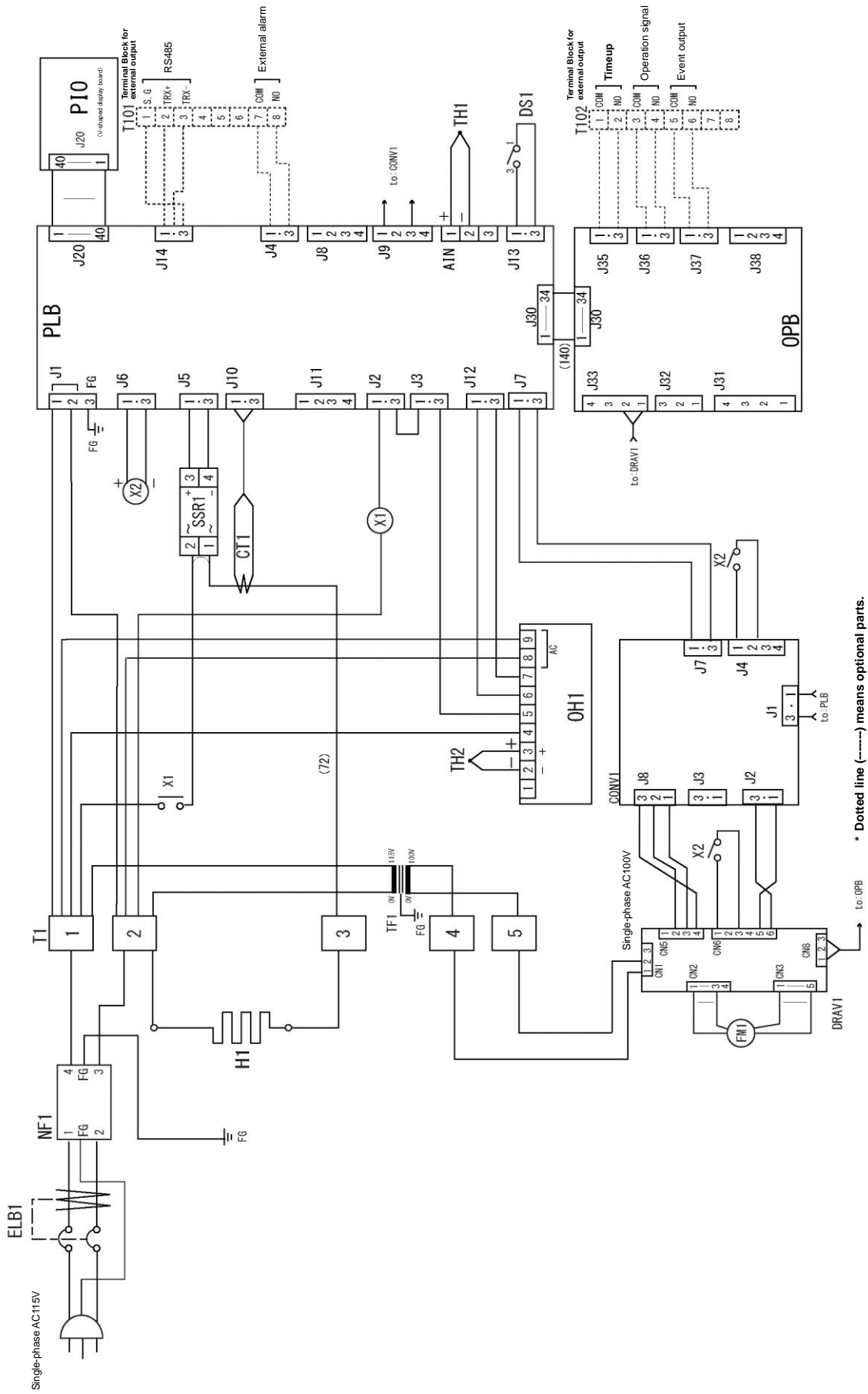

12. Wiring diagram

DNF401 Wiring diagram

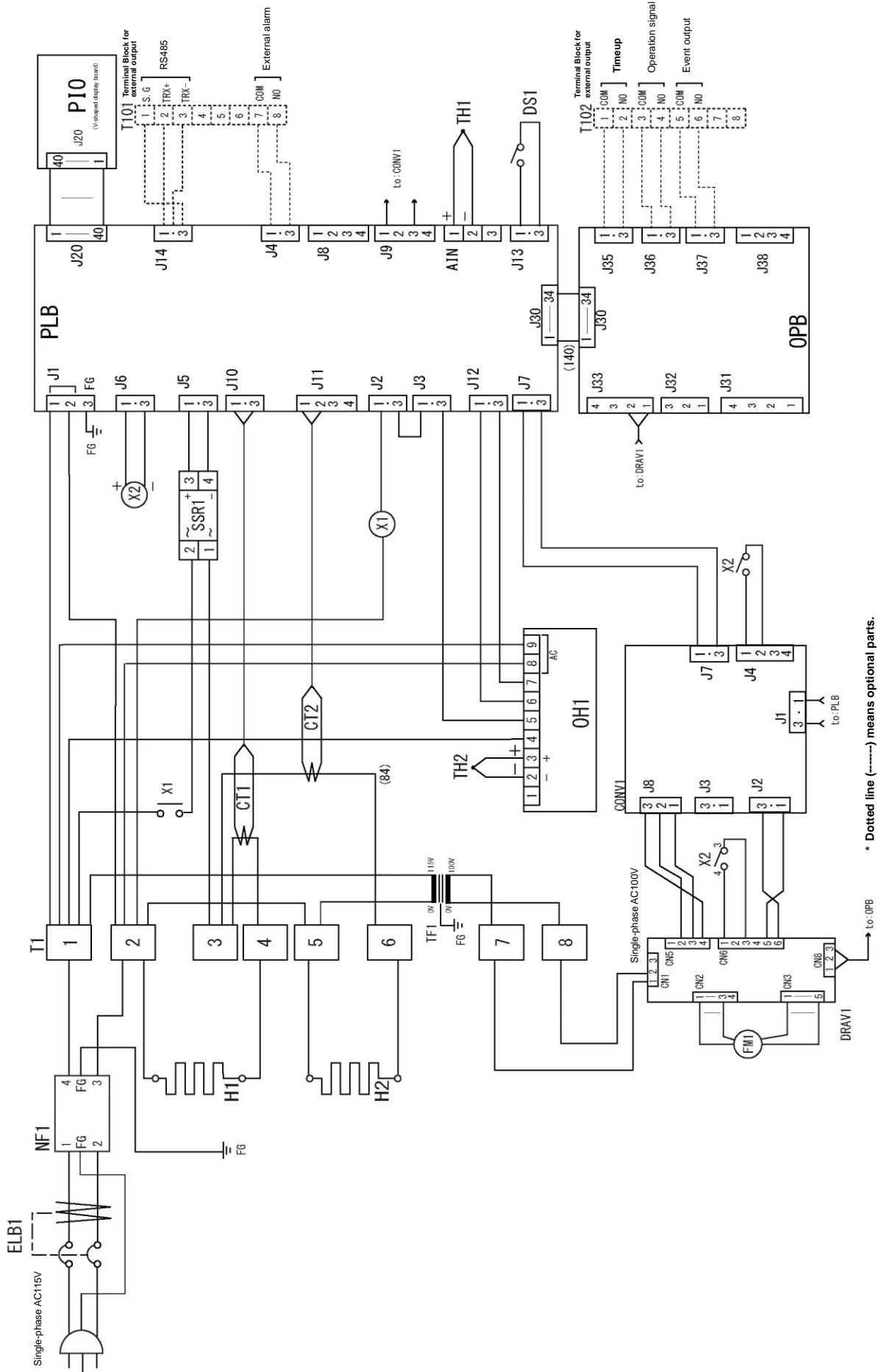

12. Wiring diagram

DNF411 Wiring diagram

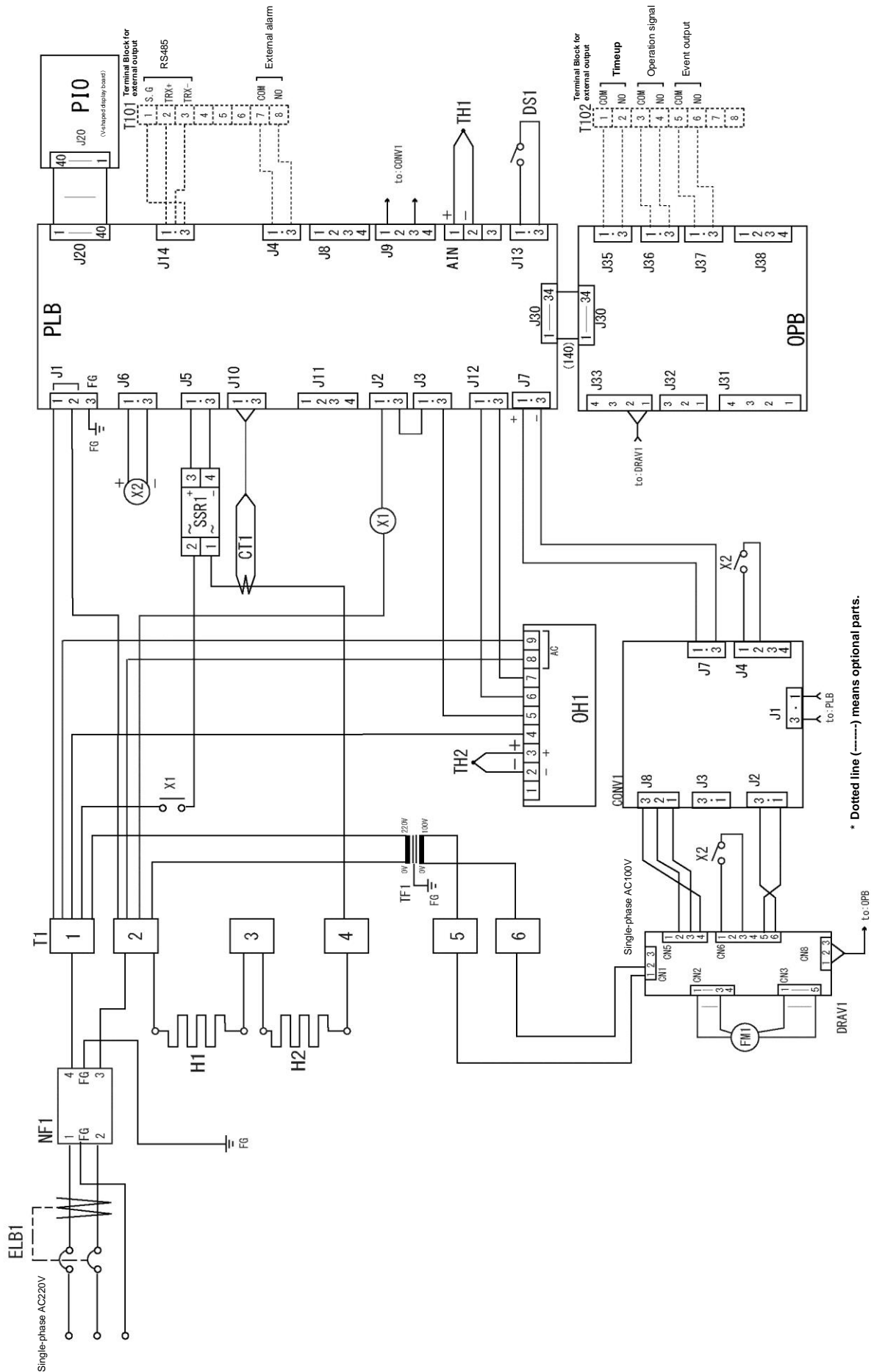

12. Wiring diagram

DNF601 Wiring diagram

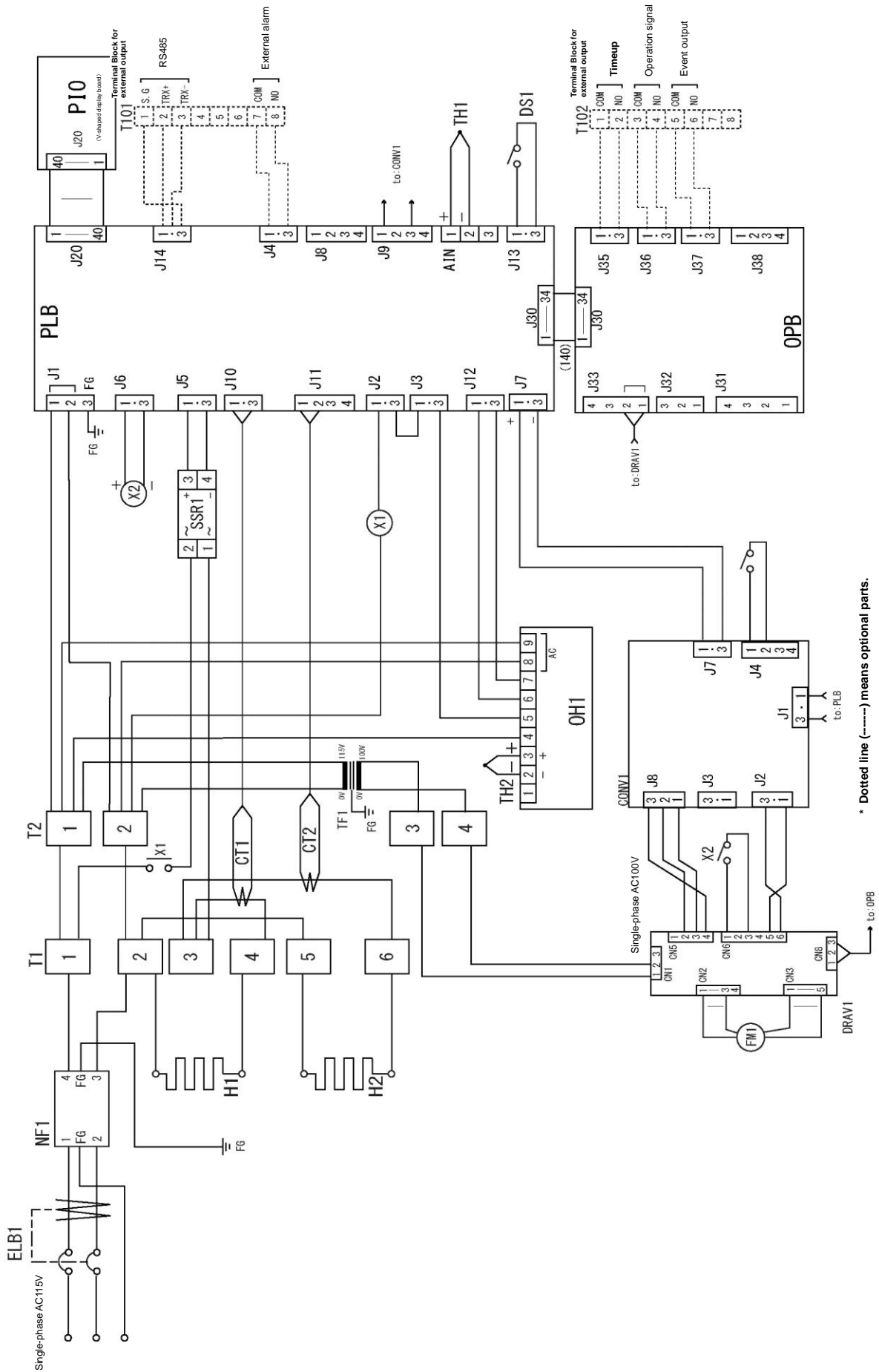

12. Wiring diagram

DNF611 Wiring diagram

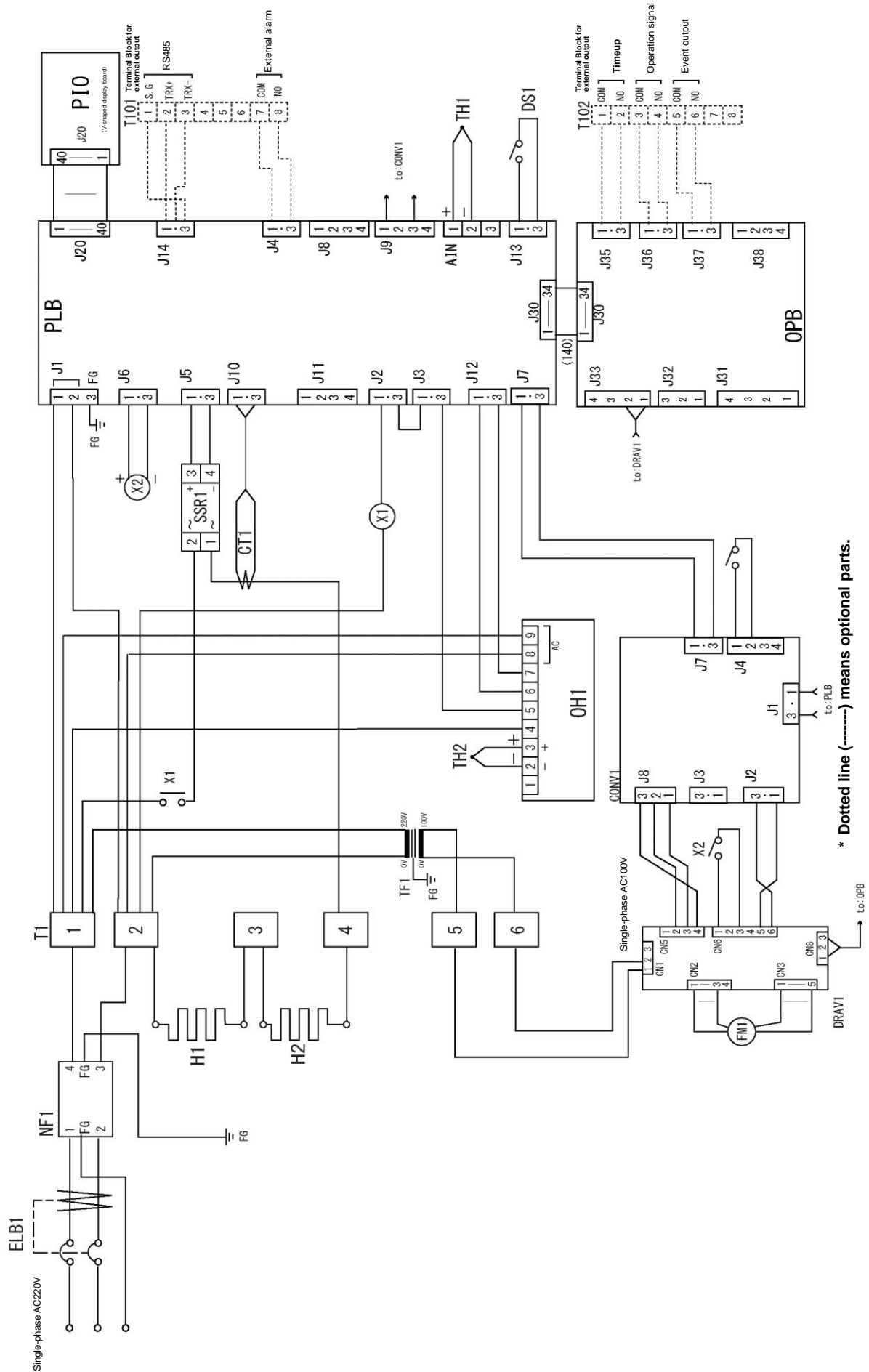

12. Wiring diagram

Wiring diagram part symbols

Symbol	Nomenclature	Symbol	Nomenclature
ELB1	Earth Leakage Breaker(ELB)	PIO	V type Display Board
T1	Terminal Block for wiring	OH1	Independent Overheat Prevention Device
T2	Terminal Block for wiring	NF1	Noise filter
SSR1	Solid State Relay	DS1	Door Switch
H1	Heater	TH1	Sensor for temperature control
H2	Heater	TH2	Sensor for Overheat Prevention
CT1	Current Sensing Element	DRAV1	Driver board
CT2	Current Sensing Element	CONV1	Signal Conversion Board
X1	Main Operation Relay	TF1	Transformer
X2	Fan Control relay		
FM1	Fan Motor		
OPB	V type Option Board		
PLB	V type Planar Board		

Optional parts

Symbol	Nomenclature	Symbol	Nomenclature
T101	Terminal Block for external output	T102	Terminal Block for external output

13. List of dangerous substances



Never process any explosive, flammable samples and also samples contained with those substances.

T

Table 13.1 List of dangerous substances

Explosive Substances	① Nitroglycol, Glycerine trinitrate, Cellulose Nitrate and other explosive nitrate esters
	② Trinitrobenzen, Trinitrotoluene, Picric Acid and other explosive nitro compounds
	③ Acetyl Hydroperoxide, Methyl Ethyl Ketone Peroxide, Benzoyl Peroxide and other organic peroxides
	④ Metallic Azide, including Sodium Azide, etc.
Explosive Substances	① Metal "Lithium" ② Metal "Potassium" ③ Metal "Natrium" ④ Yellow Phosphorus
	⑤ Phosphorus Sulfide ⑥ Red Phosphorus ⑦ Phosphorus Sulfide
	⑧ Celluloids, Calcium Carbide (a.k.a, Carbide) ⑨ Lime Phosphide ⑩ Magnesium Powder
	⑪ Aluminum Powder ⑫ Metal Powder other than Magnesium and Aluminum Powder
	⑬ Sodium Dithionous Acid (a.k.a., Hydrosulphite)
Oxidizing Substances	① Potassium Chlorate, Sodium Chlorate, Ammonium Chlorate, and other chlorates
	② Potassium Perchlorate, Sodium Perchlorate, Ammonium Perchlorate, and other perchlorates
	③ Potassium Peroxide, Sodium Peroxide, Barium Peroxide, and other inorganic peroxides
	④ Potassium Nitrate, Sodium Nitrate, Ammonium Nitrate, and other nitrates
	⑤ Sodium Chlorite and other chlorites
	⑥ Calcium Hypochlorite and other hypochlorites
Flammable Substances	① Ethyl Ether, Gasoline, Acetaldehyde, Propylene Chloride, Carbon Disulfide, and other substances with ignition point at a degree 30 or more degrees below zero.
	② n-hexane, Ethylene Oxide, Acetone, Benzene, Methyl Ethyl Ketone and other substances with ignition point between 30 degrees below zero and less than zero.
	③ Methanol, Ethanol, Xylene, Pentyl n-acetate, (a.k.a. amyl n-acetate) and other substances with ignition point between zero and less than 30 degrees.
	④ Kerosene, Light Oil, Terebinth Oil, Isopentyl Alcohol (a.k.a. Isoamyl Alcohol), Acetic Acid and other substances with ignition point between 30 degrees and less than 65 degrees.
Combustible Gas	Hydrogen, Acetylene, Ethylene, Methane, Ethane, Propane, Butane and other gases combustible at 15°C at one air pressure.

Excerpt from Table 1, Hazardous Substances, of Cabinet Order of the Occupational Safety and Health Law (substances related to Articles 1, 6, and 9)

14. Standard setup manual

*Install this Equipment according to following format (Check the format for options or customized specifications)

Model	Serial number	Installation Date	Charged Personnel or Company Name for Installation	Installation proved by	Judgment
-------	---------------	-------------------	--	------------------------	----------

No.	Item	Implementation Method	Chapter No. & Reference page of Instruction Manual	Judgment
Specifications				
1	Accessories	Check for number of accessories Against to Accessories Column.	10. Specification P.67	
2	Installation	<ul style="list-style-type: none"> Check room environment visually. Caution: Take care for environment Make installation space. 	2. Before operating the Equipment <ul style="list-style-type: none"> Precautions when installing t... P. 6	
		<ul style="list-style-type: none"> Set shelves into Chamber 	5. Handling precautions <ul style="list-style-type: none"> Set samples... P.56	
Equipment Operation				
1	Voltage of Power Source	<ul style="list-style-type: none"> Measure line voltage (power distribution board of facilities, receptacle, etc.) with voltmeter. Measure line voltage during operation. (Must meet required voltage.) Caution: Check receptacle rating or breaker on power switch board rating to meet this Equipment requirement.	2. Before operating the Equipment P.8 <ul style="list-style-type: none"> Connect Power Cord/Power Cable... P.8,9 P.9 Take care for handling Must connect grounding wire... P.67 10. Specification <ul style="list-style-type: none"> Power Supply... 	
2	Operation checking	<ul style="list-style-type: none"> Explain about names and functions of each part Execution of auto stop operation Set temp.: 100 °C Setting time :30 min	3. Names and functions of each part P11~13 <ul style="list-style-type: none"> Main unit, operational panel P.23~25 4. Operating procedure <ul style="list-style-type: none"> Auto stop operation... 	
Description				
1	Operational descriptions	Explain operations of each component and handling precautions according to Instruction Manual.	4. Operating procedure <ul style="list-style-type: none"> Prior confirmation P.15 Date & Time setting P.16~54 5. Handling precautions P.55~60 <ul style="list-style-type: none"> Warnings Cautions P.78 13. List of dangerous substances 13.1 Table of dangerous	
2	Error Codes	Explain about error codes and procedures for reset according to Instruction Manual.	8. When a trouble occurs P.63 <ul style="list-style-type: none"> Message error table P.65 Troubleshooting 	
3	Maintenance and inspection	Explain operations of each component according to Instruction Manual.	6. Maintenance method P.61 <ul style="list-style-type: none"> Daily inspection/maintenance 	
4	Completion of installation Entries	<ul style="list-style-type: none"> Fill in Installation Date and Charged Personnel or Company Name on OK and Service seal of this Equipment. Fill in necessary information to Warranty Card and hand it over to customer. Explain how to contact with service personnel. 	9. After sales service and warranty P.66 <ul style="list-style-type: none"> Request to repair parts 	

15. Reference data

DNF301

※ The data shown below is for reference only and not the guaranteed value.

① DNF301 temperature rise curve (Forced wind)

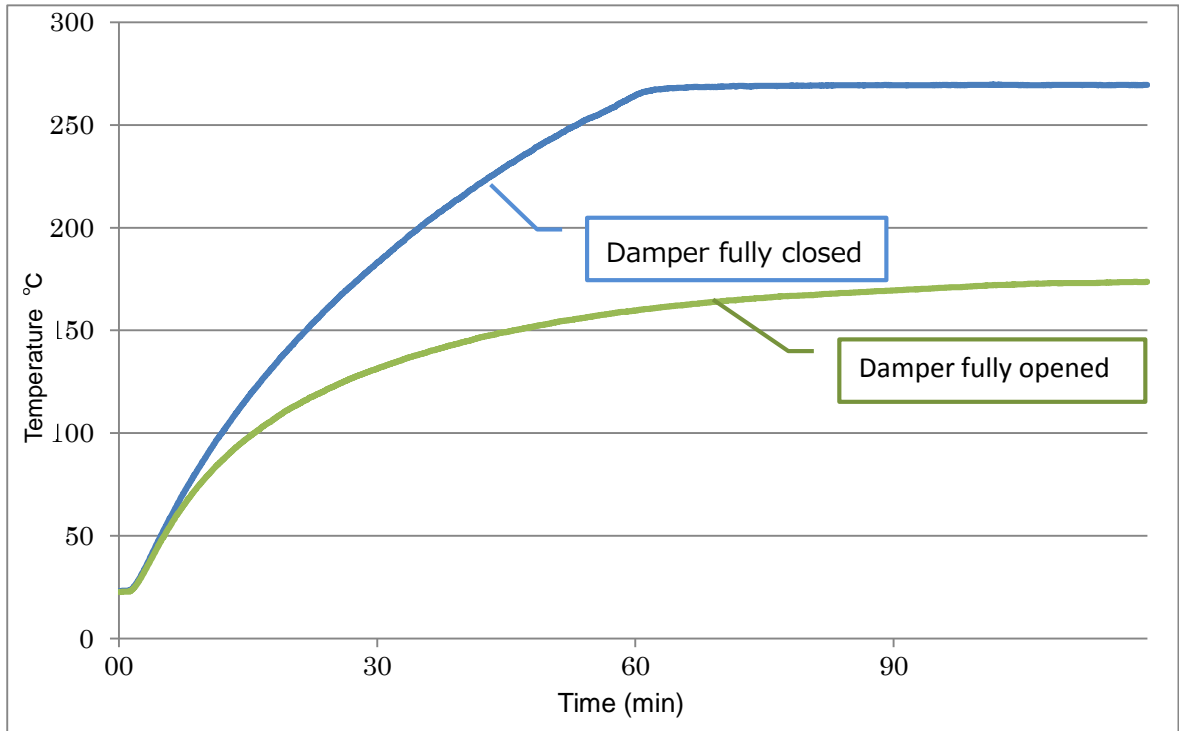

② DNF301 temperature lowering curve (Forced wind)

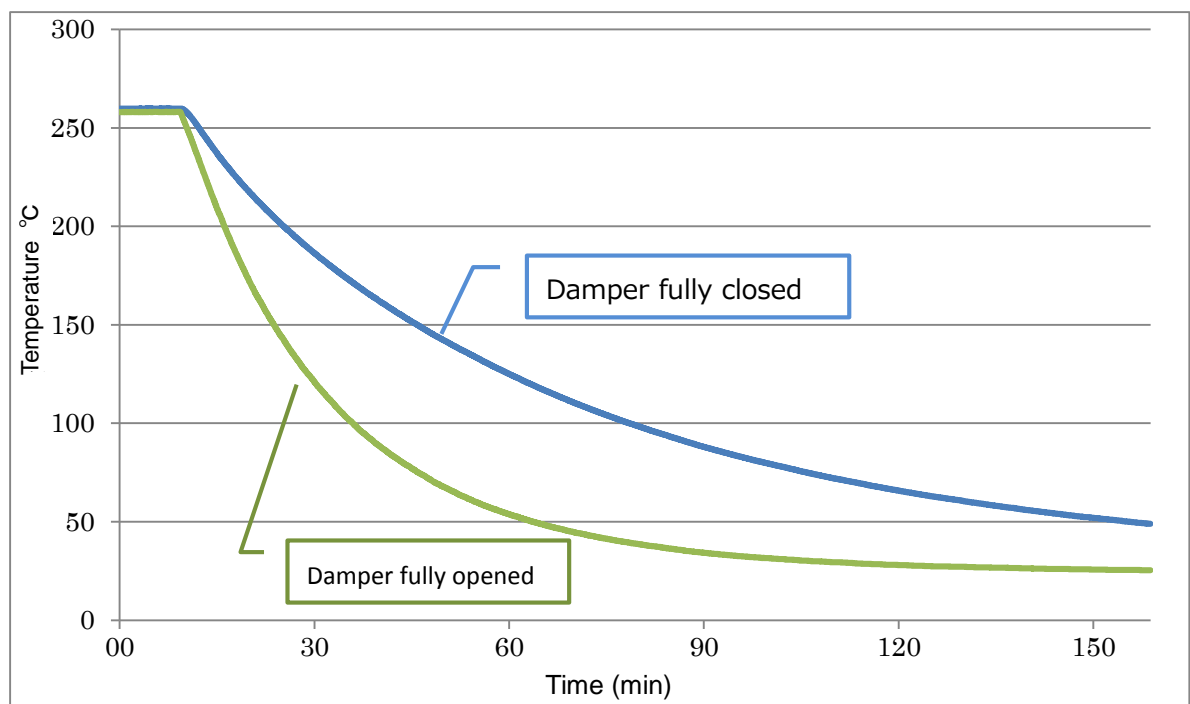

③ DNF301 temperature rise curve (Natural convection)

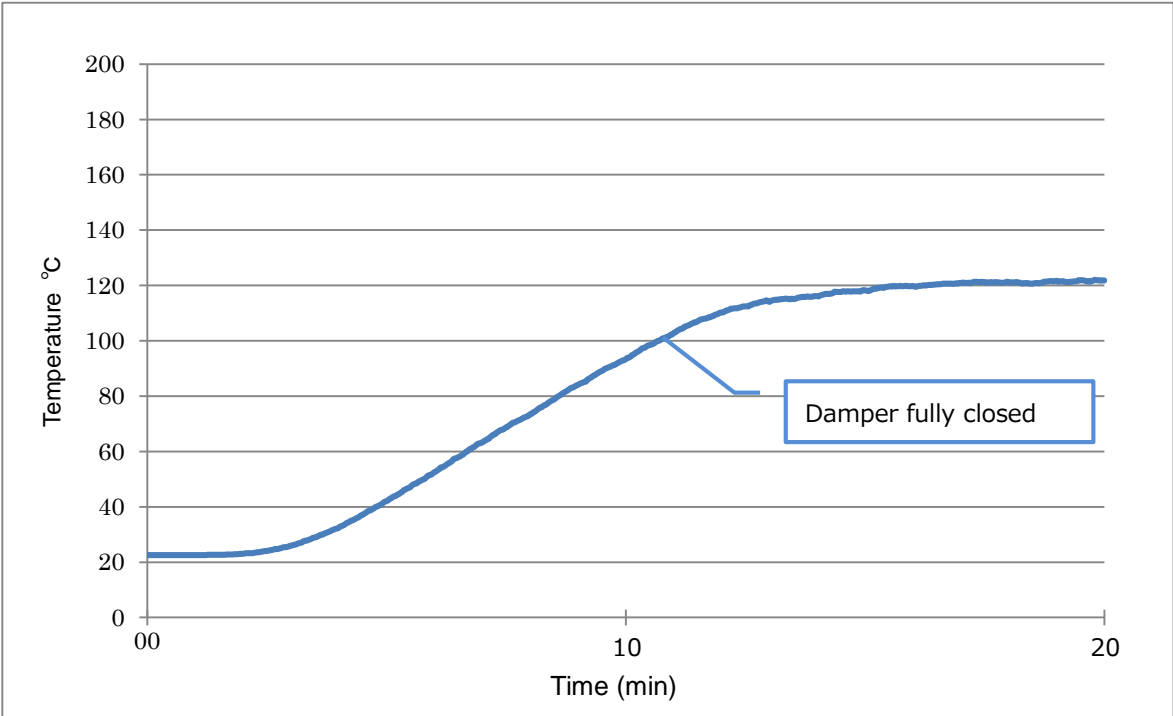

④ DNF301 temperature lowering curve (Natural convection)



※ The data shown below is for reference only and not the guaranteed value.

① ① DNF401 temperature rise curve (Forced wind)

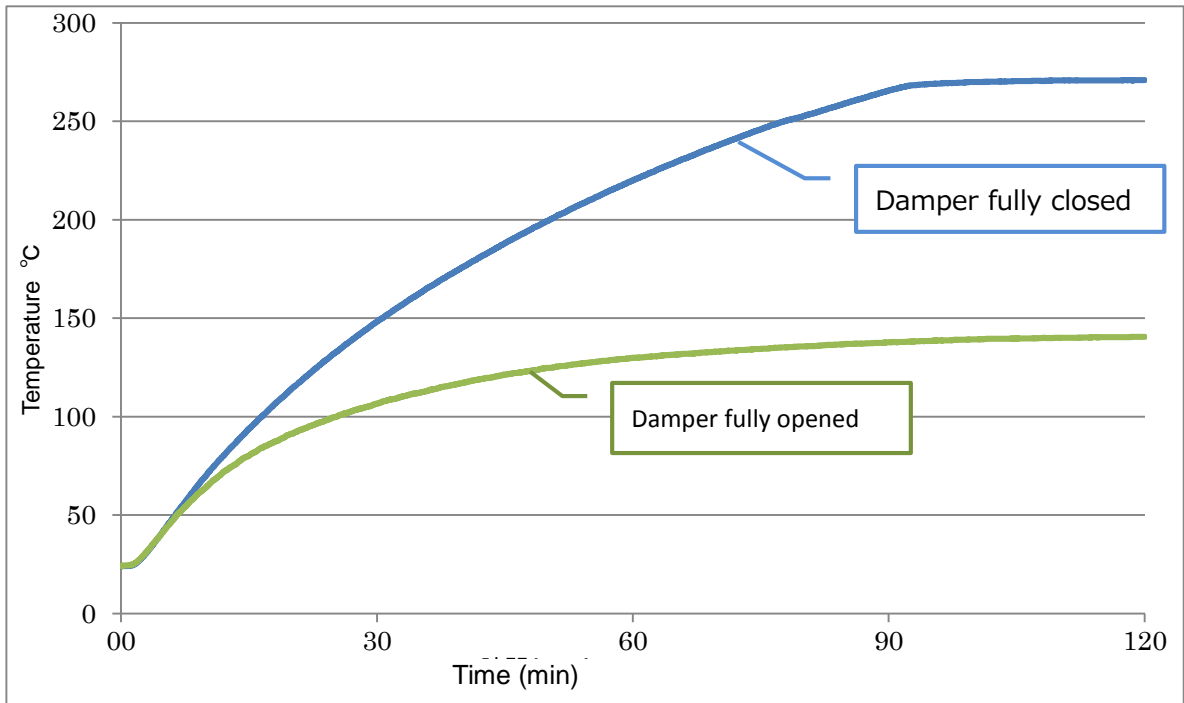

② DNF401 temperature lowering curve (Forced wind)

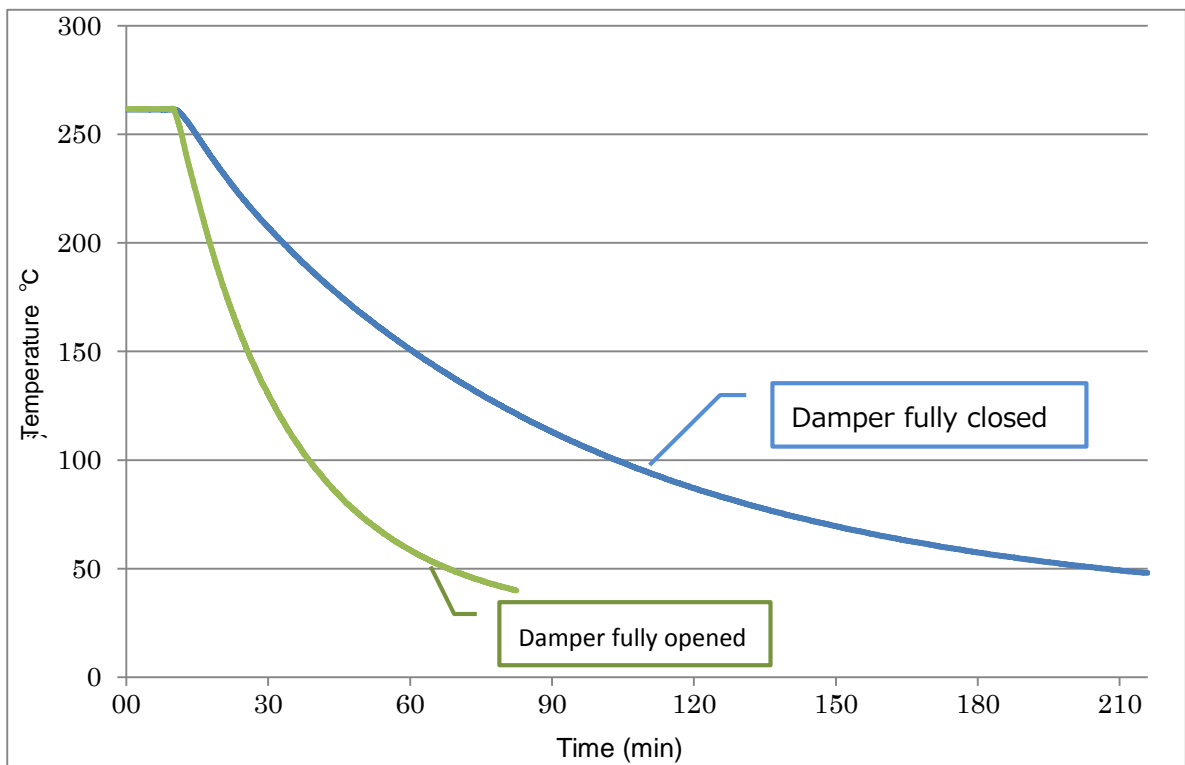

③ DNF401 temperature rise curve (Natural convection)

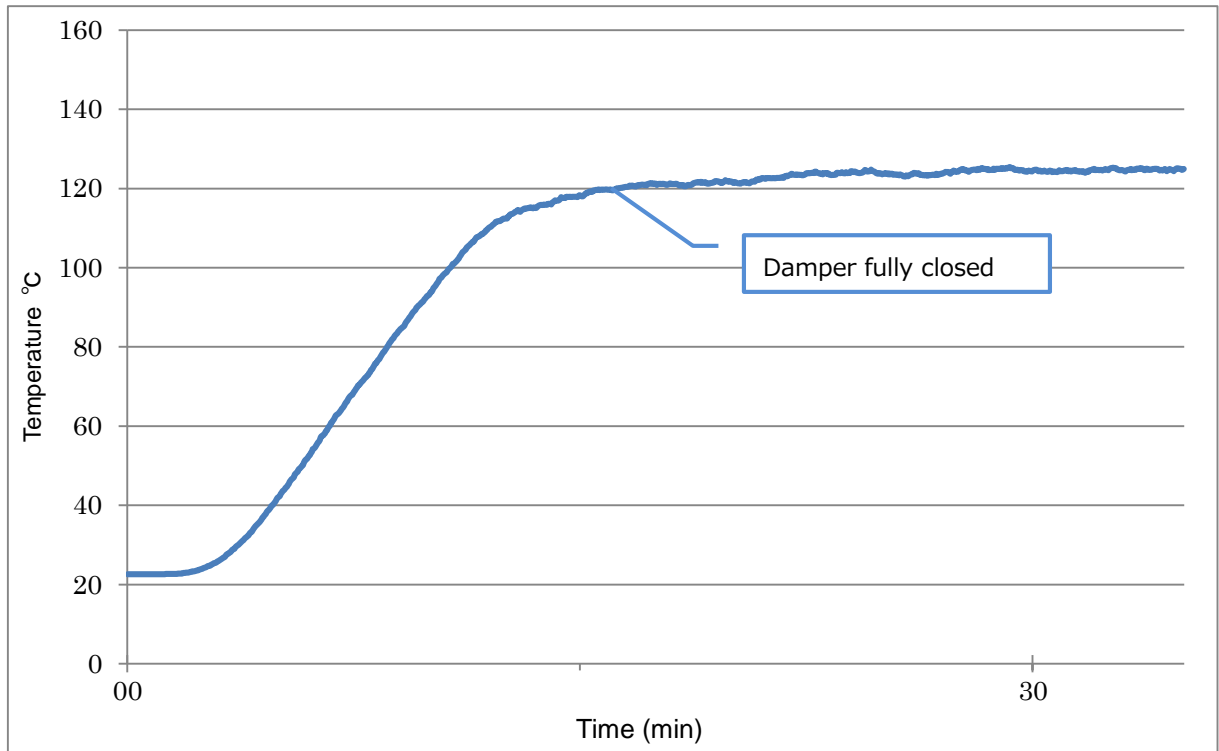

④ DNF401 temperature lowering curve (Natural convection)

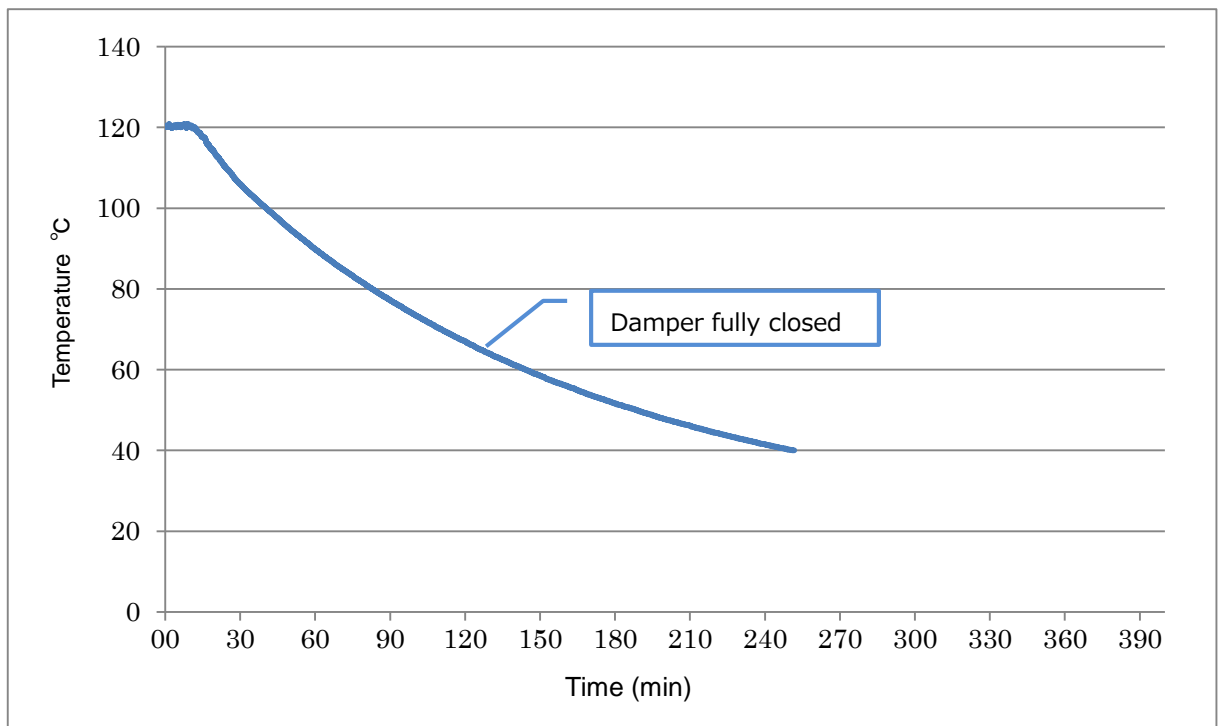

※ The data shown below is for reference only and not the guaranteed value.

① DNF601 temperature rise curve (Forced wind)

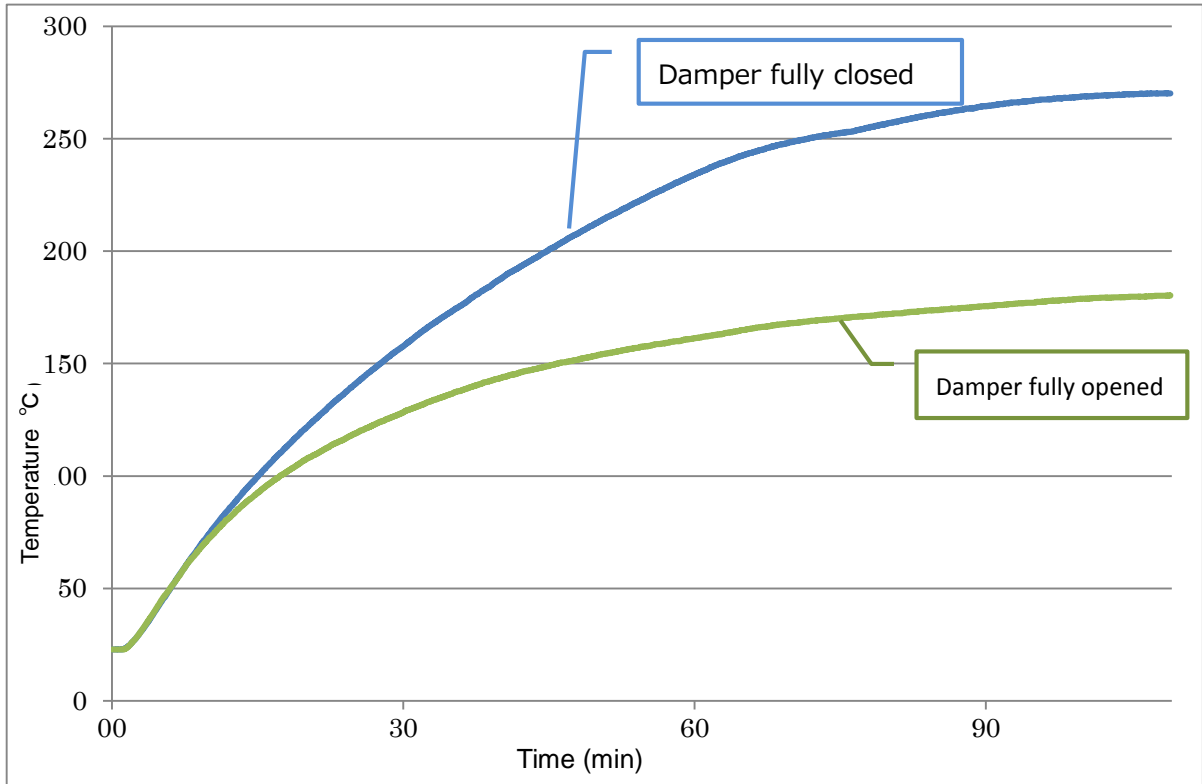

② DNF601 temperature lowering curve (Forced wind)

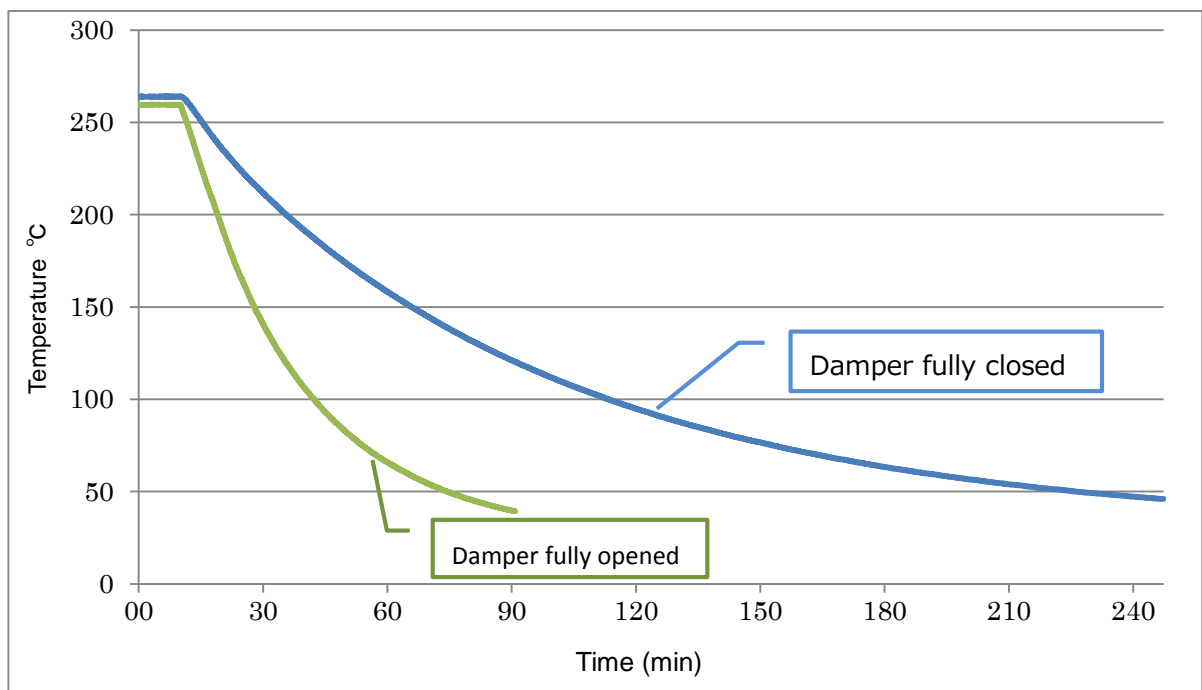

③ DNF601 temperature rise curve (Natural convection)

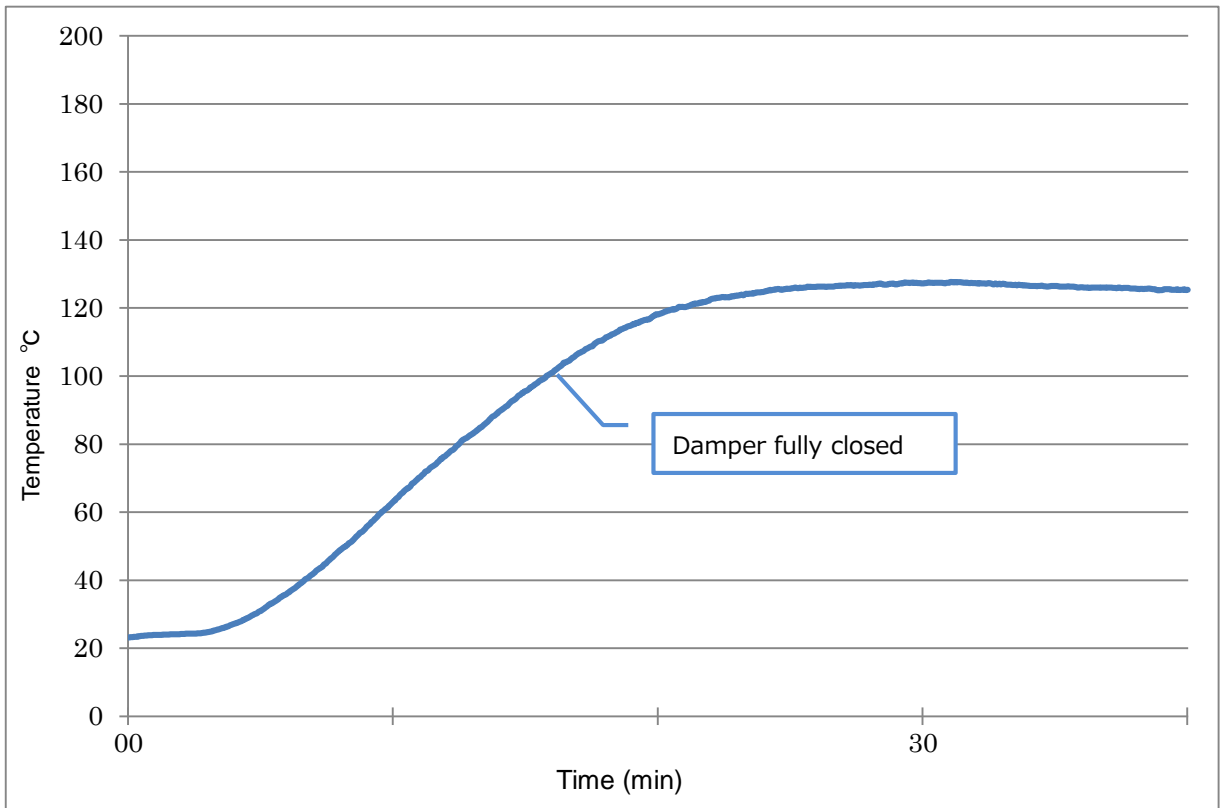

④ DNF601 temperature lowering curve (Natural convection)

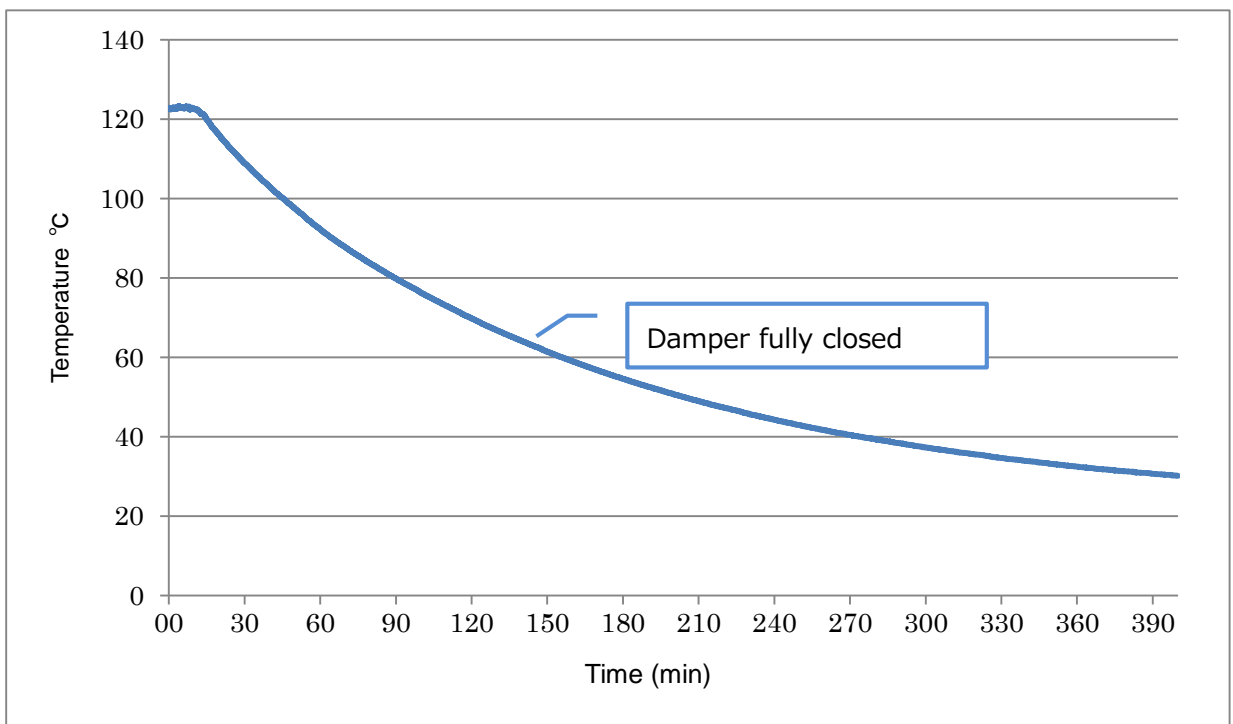

Programming sheet

Control №

Model name		Date of preparation	(Y) (M) (D)
Program pattern number		Prepared by	

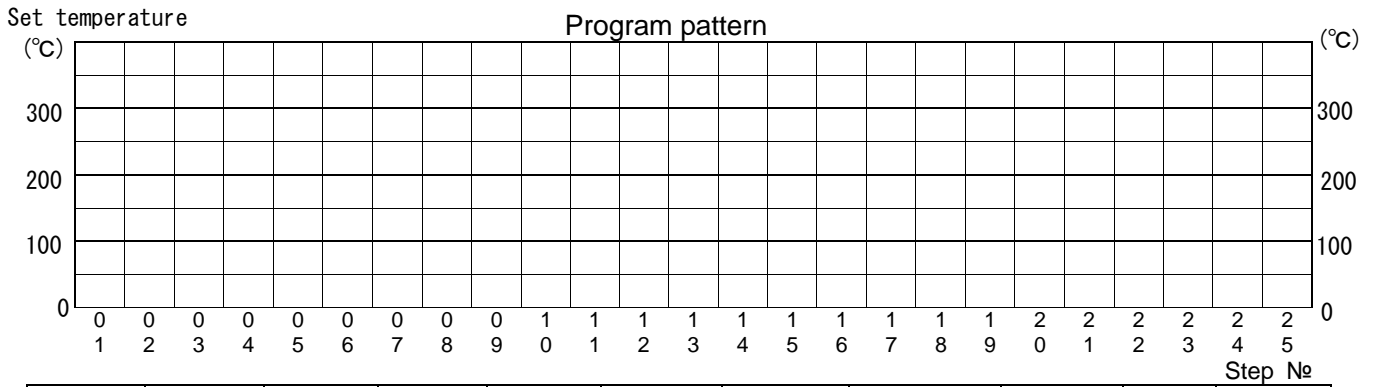

Pattern number	Step	Set temperature	Time	Repeat dstn	Number of repetitions	Wait	Event			Wind speed in operation	End	Wind speed at end
		TEMP (°C)	TIME Hr : Min	REP STEP	REP COUNT	WAIT ON/OFF	1	2	3	FAN 0~10	END: ST	FAN 0~10
P** : 00	P02 : **		:									
	01		:									
	02		:									
	03		:									
	04		:									
	05		:									
	06		:									
	07		:									
	08		:									
	09		:									
	10		:									
	11		:									
	12		:									
	13		:									
	14		:									
	15		:									
	16		:									
	17		:									
	18		:									
	19		:									
	20		:									
	21		:									
	22		:									
	23		:									
	24		:									
	25		:									
Remarks												

Note: Event and damper openness are optional items. Duplicate and use this sheet.

Limited liability

Be sure to use this Equipment strictly following the handling and operating instructions in this Instruction Manual.

Yamato Scientific Co., Ltd. assumes no responsibility for accident or malfunction caused by use of this Equipment in any way not specified in this Instruction Manual.

Never attempt to perform matters prohibited in this Instruction Manual.

Otherwise, unexpected accident may result.

Notice

- **Descriptions in this Instruction Manual are subject to change without notice.**
- **WE, as Yamato Scientific Co., Ltd. will replace this Instruction Manual with missing page or paging disorder.**

Operation Manual

Variable wind-speed constant-temperature drying oven (2in1 oven)

DNF301

DNF401/411

DNF601/611

First Edition April 10, 2017

Revised
